

RADIO NEWS



SEPTEMBER

1941

25c

In Canada 30c

HSE

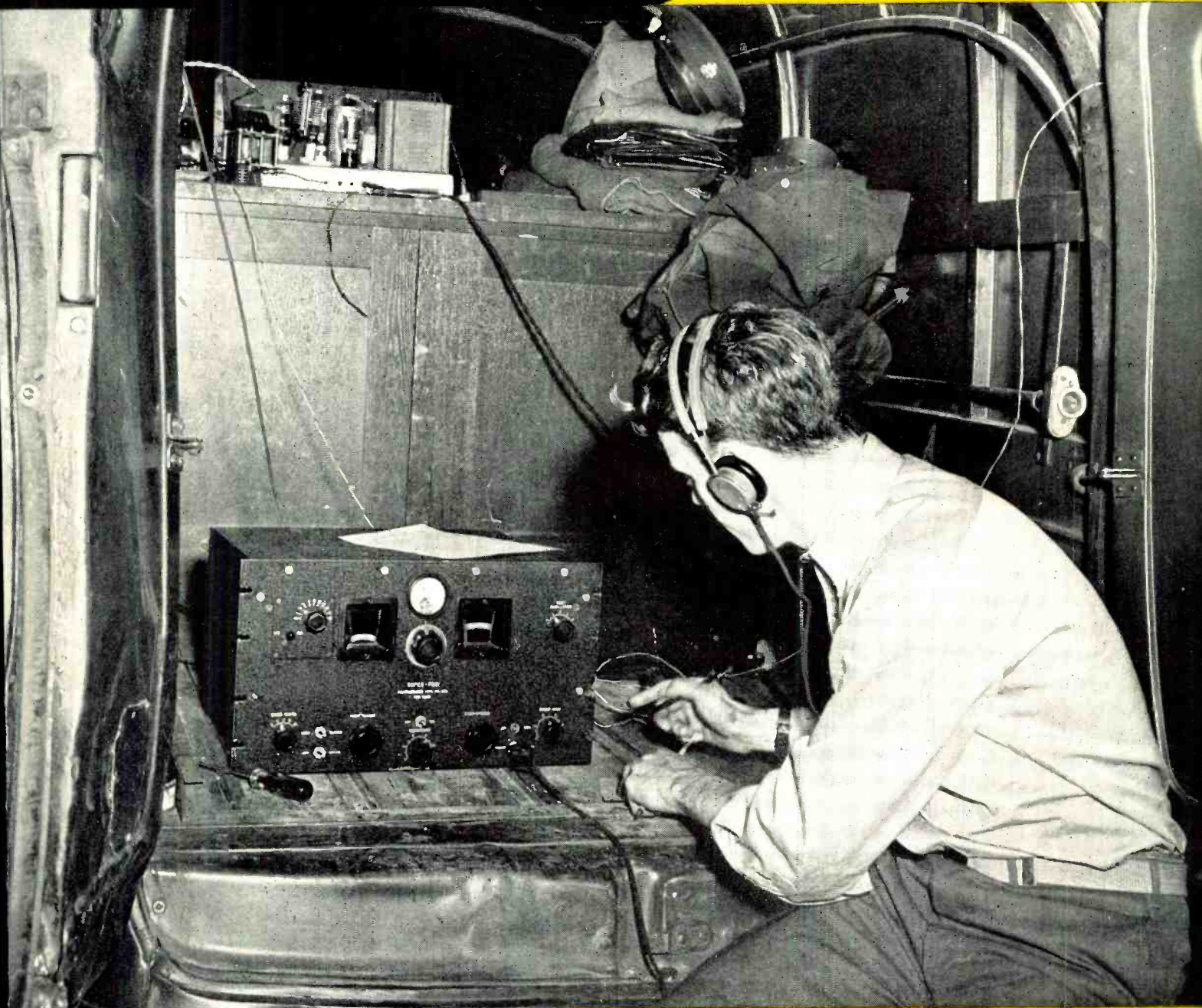

Army Emergency Field Equipment

U. H. F. SERVES AVIATION IN AIR DEFENSE

MEASUREMENTS IN RADIO SERVICING THEORY AND PRACTICE OF DISC RECORDING

Take it With You Wherever You Go!



Mounted in an attractive black crackle finished metal cabinet with rounded corners, THE SKY TRAVELER is 7 in. high—8½ in. wide—13¼ in. deep.

THE Sky-Traveler (Model S-29) is a portable designed to communications receiver tolerances. You can take it with you wherever you go, or use it at home. Operates on 110 volts AC or DC or from its self-contained batteries. Frequency coverage from 542 kc. to 30.5 mc. on 4 bands. Telescope antenna with high gain coupling circuit provides truly remarkable reception throughout the tuning range. Electrical band-spread. Automatic noise limiter. Battery life prolonged through a self-contained charging circuit. RF stage used on all bands. Sensitivity below two microvolts on all bands. Permeability tuned RF and IF circuits. Weight including batteries 18 lbs. The Sky-Traveler (Model S-29) \$69.50.



the hallicrafters co.

CHICAGO, U. S. A.

USED BY 33 GOVERNMENTS

• SOLD IN 89 COUNTRIES

A FREE LESSON SHOWED BILL HOW HE COULD MAKE GOOD PAY IN RADIO

BILL, YOU'RE ALWAYS FOOLING WITH RADIO -- OUR SET WON'T WORK -- WILL YOU FIX IT?

I'LL TRY, MARY, I'LL TAKE IT HOME TONIGHT

I CAN'T FIND OUT WHAT'S WRONG -- GUESS I'LL MAKE A FOOL OF MYSELF WITH MARY

HELLO, BILL -- GOT A TOUGH ONE TO FIX? LET ME HELP YOU

HELLO JOE -- WHERE'VE YOU BEEN LATELY -- AND WHERE DID YOU LEARN ANYTHING ABOUT RADIO?

I'VE BEEN STUDYING RADIO AT HOME, BILL, WITH THE NATIONAL RADIO INSTITUTE. YOU OUGHT TO TAKE THEIR COURSE. I'VE GOT A GOOD RADIO JOB NOW. LET'S MAKE A CIRCUIT DISTURBANCE TEST -- STARTING WITH THE AUDIO OUTPUT STAGE AND TESTING EVERY STAGE RIGHT BACK TO THE ANTENNA. LISTEN FOR THE CLICKS WHEN I TAP THE GRID LEADS

SAY -- WHERE DID YOU LEARN THAT TEST? IT'S A GOOD ONE

HERE'S THE TROUBLE, BILL, IN THE FIRST I.F. AMPLIFICATION STAGE. I LEARNED THAT TEST EVEN BEFORE I STARTED TAKING THE COURSE, BILL. IT'S DESCRIBED IN A FREE LESSON WHICH THE NATIONAL RADIO INSTITUTE SENDS YOU WHEN YOU MAIL A COUPON FROM ONE OF THEIR ADS

I'VE SEEN THEIR ADS BUT I NEVER THOUGHT I COULD LEARN RADIO AT HOME -- I'LL MAIL THEIR COUPON RIGHT AWAY

I'M CONVINCED NOW THAT THIS COURSE IS PRACTICAL AND COMPLETE. I'LL ENROLL NOW

AND THEN I CAN MAKE REAL MONEY FIXING RADIO SETS

OR INSTALL AND SERVICE LOUD SPEAKER SYSTEMS

OR GET A JOB WITH A RADIO BROADCASTING OR TRANSMITTING STATION

AVIATION RADIO, POLICE RADIO, TELEVISION, ELECTRONIC CONTROLS -- RADIO IS SURELY GOING PLACES. AND THE NATIONAL RADIO INSTITUTE HAS TRAINED HUNDREDS OF MEN FOR JOBS IN RADIO

I will send you a Lesson on Radio Servicing Tips FREE TO SHOW HOW PRACTICAL IT IS TO TRAIN AT HOME FOR GOOD JOBS IN RADIO

Every man who works on a Radio Receiver, either professionally or as a hobby, should have a copy of my Free Sample Lesson, "Radio Receiver Troubles--Their Cause and Remedy." I will send you your copy without obligation if you will mail the Coupon below. It will show you how practical my lessons are--give you a real idea of the vast amount of information my Course gives you.

Why Many Radio Technicians I Train Make \$30, \$40, \$50 a Week

N.R.I. trained Radio Technicians hold good jobs in practically every branch of Radio, selling, servicing, installing, repairing, home and auto Radio sets. N.R.I. trained Radio Operators have good jobs in Broadcasting, Commercial, Aviation, Police, Ship, Radio Stations. Many operate their own part or full-time Radio businesses, fixing, selling Radio sets. Others make good money in Public Address work and other branches of the Radio Industry.

My Course is thorough and practical. I give you basic training in Radio Theory and Engineering Practice which enables you to understand the operation and design of practically every type of Radio apparatus.

EXTRA PAY IN ARMY, NAVY, TOO

Every man likely to go into military service, every soldier, sailor, marine, should mail the Coupon Now! Learning Radio helps men get extra rank, extra prestige, more interesting duty at pay up to 6 times base pay. Also prepares for good Radio jobs after service ends. IT'S SMART TO TRAIN FOR RADIO NOW!

You understand your work--know just what to do--instead of just relying on mechanical ability to fix a few common faults and make a few simple adjustments. That's why many men who have been in Radio before enrolling report that my Course helped them make more money, win success. I train you, too, for Television, a promising field of future opportunity.

Beginners Quickly Learn to Earn \$5 to \$10 a Week Extra in Spare Time

Nearly every neighborhood offers opportunities for a good part-time Radio Technician to make extra money fixing Radio sets. I give you special training to show you how to start cashing in on these opportunities early. You get Radio parts and instructions for building test equipment, for conducting experiments that give you valuable, practical experience. My 30-30 method of training--half with Radio parts I send you, half studying my Lesson Texts--makes learning Radio at home interesting, fascinating, practical.

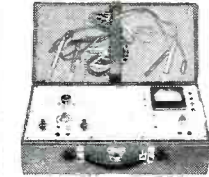

You Get This Professional Radio Servicing Instrument

as part of my Course to help you make more money, do better Radio work. For full details, mail the Coupon.

MAIL THE COUPON

Get my Sample Lesson and 64-page Book "Rich Rewards in Radio" at once. They're free. See what Radio offers you as a skilled Radio Technician or Operator. Learn how practical my Course really is. Read letters from more than 100 men I have trained, telling what they are doing, earning. Mail the Coupon NOW--in an envelope or paste it on a penny postal.

J. E. SMITH, President, Dept. IJR, National Radio Institute, Washington, D. C.



J. E. SMITH, President National Radio Institute
Established 25 years

He has directed the training of more men for the Radio Industry than anyone else.



YOU CERTAINLY KNOW RADIO SOUNDS AS GOOD AS THE DAY I BOUGHT IT.

THANKS! IT CERTAINLY IS EASY TO LEARN RADIO THE N.R.I. WAY. I STARTED ONLY A FEW MONTHS AGO, AND I'M ALREADY MAKING GOOD MONEY.

THIS SPARE TIME WORK IS GREAT FUN AND PRETTY SOON I'LL BE READY FOR A FULL TIME JOB

OH BILL - I'M SO GLAD I ASKED YOU TO FIX OUR RADIO. IT GOT YOU STARTED THINKING ABOUT RADIO AS A CAREER, AND NOW YOU'RE GOING AHEAD SO FAST

OUR WORRIES ARE OVER. I HAVE A GOOD JOB NOW, AND THERE'S A BIG FUTURE AHEAD FOR US IN RADIO

OH BILL - I'M SO GLAD I ASKED YOU TO FIX OUR RADIO. IT GOT YOU STARTED THINKING ABOUT RADIO AS A CAREER, AND NOW YOU'RE GOING AHEAD SO FAST

J. E. Smith, President, Dept. IJR, National Radio Institute, Washington, D. C.

Mail me FREE without obligation, Sample Lesson and 64-page book "Rich Rewards in Radio," which tells about Radio's opportunities and explains your 50-50 method of training men at home. (No salesman will call. Write plainly.)

Name _____ Age _____

Address _____

City _____ State _____

14X-1



by THE EDITOR

TWO important steps have been taken in radio recently to the aid of National Defense. One is the decision of the *OPM* to allow more essential materials to be used for the manufacture of replacement parts for the servicing of existing radio receivers. The other is the taking over of a 300 kc. portion of the 80 Meter amateur band for use in the air defense communications field.

The following statement was made by Kenneth B. Warner, Managing Secretary of the *American Radio Relay League*, national organization of radio amateurs, in connection with the *Federal Communications Commission's* press release of July 22, 1941, wherein notice was given to the licensees of amateur radio stations of its intention to take action over the next few months to release portions of certain frequency bands at present assigned to amateur stations to defense uses by making them available for the large scale military aircraft pilot training program:

"The action taken by the *F. C. C.* this afternoon was with the prior knowledge of the *American Radio Relay League*, and its details were worked out with our active collaboration, as representatives of the organized radio amateur body of this country. We are aware of the great need of communications facilities created by the vast enlargement of the pilot training program, and appreciate the vital significance of this program in the development of a strong national defense. If it is inevitable that we, the radio amateurs, are called upon, along with other radio services, to release, temporarily, some of our space on the air during the present emergency, we are proud to make the sacrifice in behalf of a project of such awe inspiring dimensions and of such importance to every American citizen. Our loan of some of our frequencies to this program constitutes another contribution by the United States radio amateur to the defense of this country."

RADIO NEWS believes that action should be taken at this critical time, and we further believe that the *F. C. C.* values the services rendered by the amateur and will take proper steps to see that these frequencies are returned when the present emergency is over.

* * *

The recent article appearing in *READER'S DIGEST* for August 1941, entitled, "The Radio Repair Man Will Gyp You if You Don't Watch Out!", is bound to stir up a considerable misunderstanding between the radio serviceman and the public. Mr. William Riis, in his article, stated that as a result of a recent investigation, 65% of radio servicemen were dishonest.

(Continued on page 59)



Trade-Mark Registered

Including Articles on **POPULAR TELEVISION**

The Magazine for the radio amateur
experimenter, serviceman and dealer

Vol. 26, No. 3

Contents for September, 1941

FEATURES

- U. H. F. in Aviation** Sgt. Charles J. Schauers **6**
The year 1943 will feature major frequency changes in aviation.
- As I See It!** John F. Rider **9**
The "Dean of Radio Servicemen" analyzes an important situation.
- Ultra Modern Transmitter Design** Morton B. Kahn **10**
Amateurs will be interested in new transmitter design features.
- Measurements in Radio Servicing** Willard Moody **14**
Every serviceman should read this treatise on testing receivers.
- Theory & Practice of Disc Recording, Part I**
Oliver Read, W9ETI **17**
A knowledge of fundamentals is essential to make good records.
- 3-Band UHF Super Regen** Clark E. Jackson **18**
An inexpensively-built receiver for the amateur and short-wave listener.
- Portable All-Wave Radio** Raymond B. Frank, W9JU **21**
This set is capable of giving a high order of efficiency in portable work.
- U. S. Army Air Communications** Capt. J. R. Johnston **24**
An illustrated story of one of Uncle Sam's radio training centers.
- Build This Channel Substitute** Peter T. Williamson **28**
This new servicing instrument saves much time in receiver analysis.
- National Defense and the 1942 Radio** Lewis Winner **31**
Major changes are being made in receiver design and in replacement parts.
- Beginner's 14 Watt Amplifier** L. M. Dezettel **33**
Excellent fidelity may be had with this easily-built unit.

Cover Picture: Signal corps operator using field equipment.

DEPARTMENTS

What's New in Radio 37	Manufacturer's Literature 40	The Video Reporter 45
Hamchatte 35	Aviation Radio 32	Ring the Bell 30
QRD? 38	Washington Communi- cation 16	Serviceman's Experi- ences 23
Bench Notes 13	Police Radio 20	Servicemen's Cases 60
Technical Review 50		New Tubes 34

Copyright 1941
ZIFF-DAVIS PUBLISHING COMPANY
Member of the Audit Bureau of Circulations

RADIO NEWS is published monthly by the Ziff-Davis Publishing Company at 608 S. Dearborn St., Chicago, Ill., William B. Ziff, Publisher; B. G. Davis, Editor; Oliver Read, W9ETI, Technical Editor; Raymond Frank, W9JU, Laboratory Technician; Herman R. Bollin, Art Director; H. G. Strong, Circulation Manager; S. L. Cahn, Advertising Manager, New York Office, 270 Madison Ave. Subscription \$2.50 per year; single copies, 25 cents; foreign postage \$1.00 per year additional, Canada 50c additional. Subscribers should allow at least 2 weeks for change of address. All communications about subscriptions should be addressed to: Director of Circulation, 608 S. Dearborn St., Chicago, Ill. Entered as second class matter March 9, 1938, at the Post Office, Chicago, Illinois, under the Act of March 3, 1879. Entered as second class matter at the Post Office Department, Ottawa, Canada. Contributors should retain a copy of contributions. All submitted material must contain return postage. Contributions will be handled with reasonable care, but this magazine assumes no responsibility for their safety. Accepted material is subject to whatever adaptations, and revisions, including "by-line" changes, necessary to meet requirements. Payment will be made at our current rates upon acceptance and, unless otherwise specified by contributor, all photographs and drawings will be considered as constituting a part of the manuscript in making payment.

DAVEGA

AMATEUR DIVISION, 63 Cortlandt St., N. Y., N. Y.
World's Largest Radio Dealer

The New 1942 SKYRIDER 32

Engineered by Hallicrafters to produce superior communications performance, the new Sky-rider 32 is a 13 tube, 6 band receiver covering everything on the air from 500 kc. to 40 mc. Two stages of preselection. Calibrated band-spread inertia controlled. Micrometer scale tuning inertia controlled. Tone and AC on-off. Beat frequency oscillator. AF gain—RF gain. Crystal phasing. Adjustable noise limiter. Send-receive switch—AVC-BFO switch.



80/40/20/10 meter amateur bands calibrated. Wide angle "S" meter. Push-pull high fidelity audio output. 6-step wide range variable selectivity. \$149.50.



LEACH Model L Recording Panels

Wide range magnetic cutting head. Special G. E. split phase recording motor. Quadrant worm gear drive. 12½" aluminum die cast turntable.

REGULAR PRICE ... \$59.50

OUR PRICE

\$29.50

Easy to connect to radio or amplifier

Echophone Model EC-2

The communications buy of the year! Eight tubes. Three bands. Tunes from 550 kc. to 30 mc. Five inch PM dynamic speaker. Preselection on all bands. Calibrated bandspread scale on 80/40/20/10 meter amateur bands. Automatic noise limiter. Electrical bandspread. Operates on 115 volts AC-DC. Now you can have all these amazing features at the remarkably low price of \$29.95.

HALLICRAFTER S. X. 23

8 bandswitch positions
Six step selectivity
Completely shielded
Improved crystal circuit

Regular \$115.00

Special \$74.50



AMATEUR DIVISION
63 CORTLANDT STREET
NEW YORK, N. Y.

DAVEGA



Complete UHF components set up for test before installation in the aircraft. Receiver covers 21-29 mc. range.

U.H.F. IN AVIATION

by **STAFF SGT. CHARLES J. SCHAUERS**

Ultra-high radio frequencies will be adopted by Civil and Military Aviation in 1943. More reliable coverage of short and medium distances thus will be available.

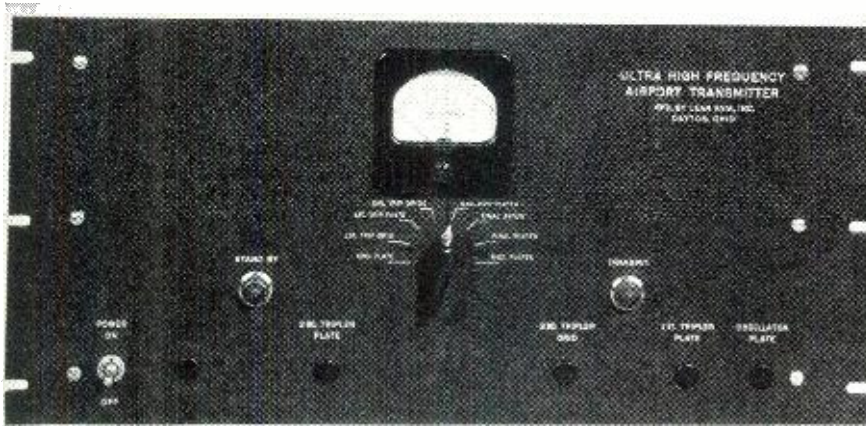

Above: Front view of new UHF airport transmitter for rack or panel mtg.

Below: Radio Receptor's ultra-high frequency monitor receiver chassis.

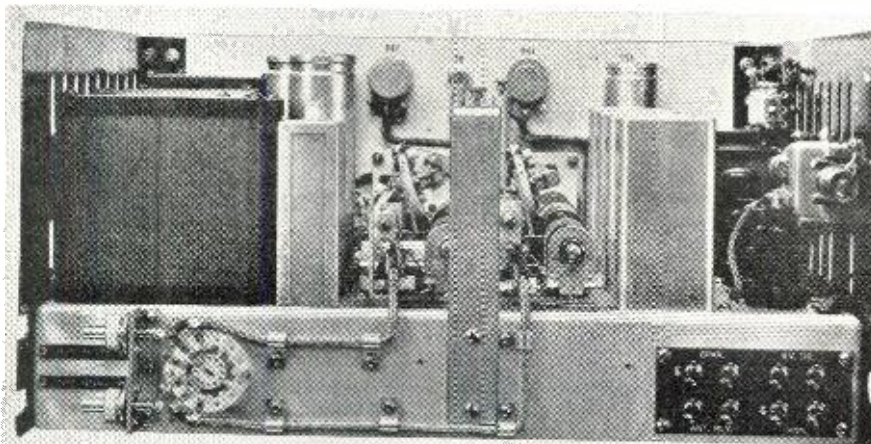

Part I



The Author

ULTRA high frequency transmission and reception is now definitely out of the laboratory and in the hands of the field engineer for application to his specific problems. It is now rapidly taking its place in many industries as

a capable servant, and in a short time will coordinate with, but not be subordinate to, medium or low frequency activity.

Notable among the many applications that we have read and heard about, not infrequently, are those that concern aviation.

It was announced in *RADIO NEWS'* Washington Communication Column (Feb. 41) that all U. S. aircraft would be shifted to UHF. Under the plans controlling the proposed shift, this UHF changeover will be accomplished by the first of January, 1943. This, of course, will mean more work for those engaged in aeronautical radio manufacturing, servicing, installation and operation. It will provide more new jobs for those who are technically qualified, and no doubt open up new avenues in UHF radio research; especially as it concerns aviation.

UHF can be, and will be used for radio range navigation systems, airport traffic control work, improved blind landing systems using the "angle



A clear area should be selected for the orientation of the plane when determining antenna location.

approach" system, radio controlled aircraft for *military* purposes; and general communications work in the aviation services. Today, it is being used quite extensively for operation of the absolute altimeter, the marker beacon system of station location, radio teletype, and the aircraft facsimile system.

It is common knowledge to most of us that the *Civil Aeronautics Administration* (CAA), the *United States Army Air Corps Research Center* and other branches of the Armed Forces, and the Airlines have experimented with UHF radio equipment for aviation usage quite extensively. And now that warranted new applications have been found, we find a very pronounced emphasis being placed on the "ultra" in UHF.

Installations of new UHF radio ranges between New York and Chicago on an "experimental" basis are being made by the CAA. These will be in operation early this summer. To take advantage of, and to test these new facilities, the Airlines have purchased new UHF equipment. Too, experiments have been conducted for quite sometime now with UHF systems to be used for airport traffic control work. The results of these experiments were most gratifying, and it is expected that the next four years will find every licensed airport equipped to utilize UHF traffic control facilities, because the 278 kilocycle (kc) channel now nationally used for communicating with itinerant and local aircraft, has many drawbacks not found in the new UHF channels.

It is safe to say here, that the outcome of the tests of both the ranges and the traffic control systems will prove more interesting to those technically interested in radio navigation and aviation radio communications; and in the end they will no doubt find that UHF communications facilities will gradually supersede the systems now employed.

UHF usage in the aviation services will in time, no doubt, change the entire communications and "navigation" setups. Keeping this in mind then, it would seem very worthwhile for those engaged in aviation radio or those con-

templating it, to avail themselves of all information concerning the latest UHF developments and applications and to get in on the "ground floor" in the earliest stages of these developments, in order that they might be adequately equipped both mentally and materially when the time comes.

Today, many dollars are being spent for renovating the present low frequency radio range systems, etc., while the UHF tests are moving toward their consummation. Some wonder at this. However, as in all improvements which usually prove to be what research workers have been striving for, much money is usually spent on existing facilities until new facilities under projection prove meritorious. We know that time is the elemental factor in any new project, especially one of National concern. Needless to say, it will take time to "standardize" frequency allocations, and due to National Defense requirements, more time will be needed to obtain the necessary Government allotments for an "all-out" changeover.

Those aircraft owners now owning two-way radio installations, need not fear immediate obsolescence; and those contemplating the purchase of a two-way radio installation should, by all means, do so! With a minimum of three years equipment usage for the amount involved, and with the added "safety insurance" received by installing two-way radio equipment in their aircraft, purchase should not be deferred.

Due to the cost of the aircraft equipment designed for UHF operation at present, and due to National Defense requirements, the light plane flyer is only interested in the completed tests and final decisions; but as soon as the program is completed, and it is found that the new facilities offer more stability, greater freedom from interferences of various kinds, and in general more efficiency, the aircraft radio manufacturer will no doubt have designed sets in the meantime specifically for the private aircraft owner which will come within his "budget allotments."

It has been said, that enterprising manufacturers will find ways and means for utilizing a great part of the present equipment owned by the private aircraft owner for UHF opera-

UHF traffic-control transmitter at Floyd Bennett airport. Tuning controls are placed behind metal doors. Note gas pressure gauge, on top, for co-axial feeder.

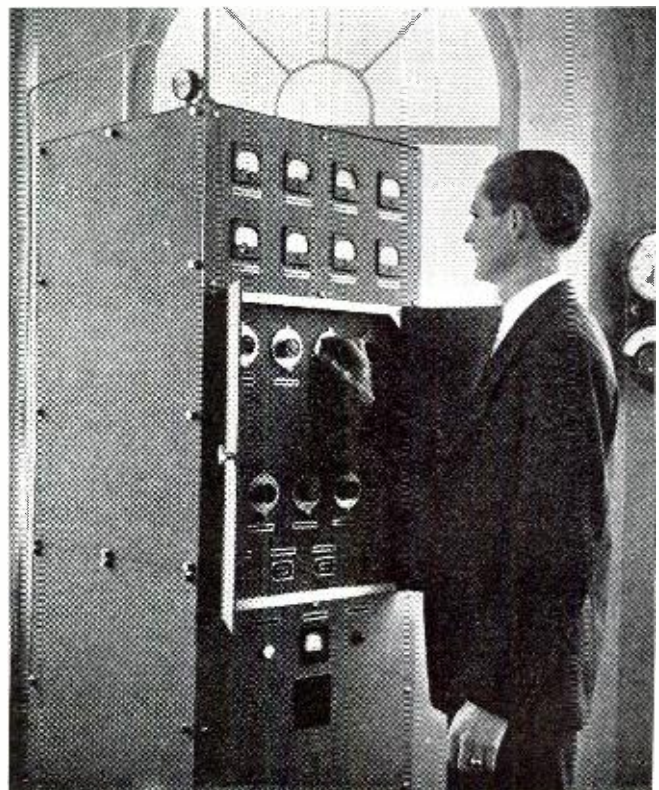

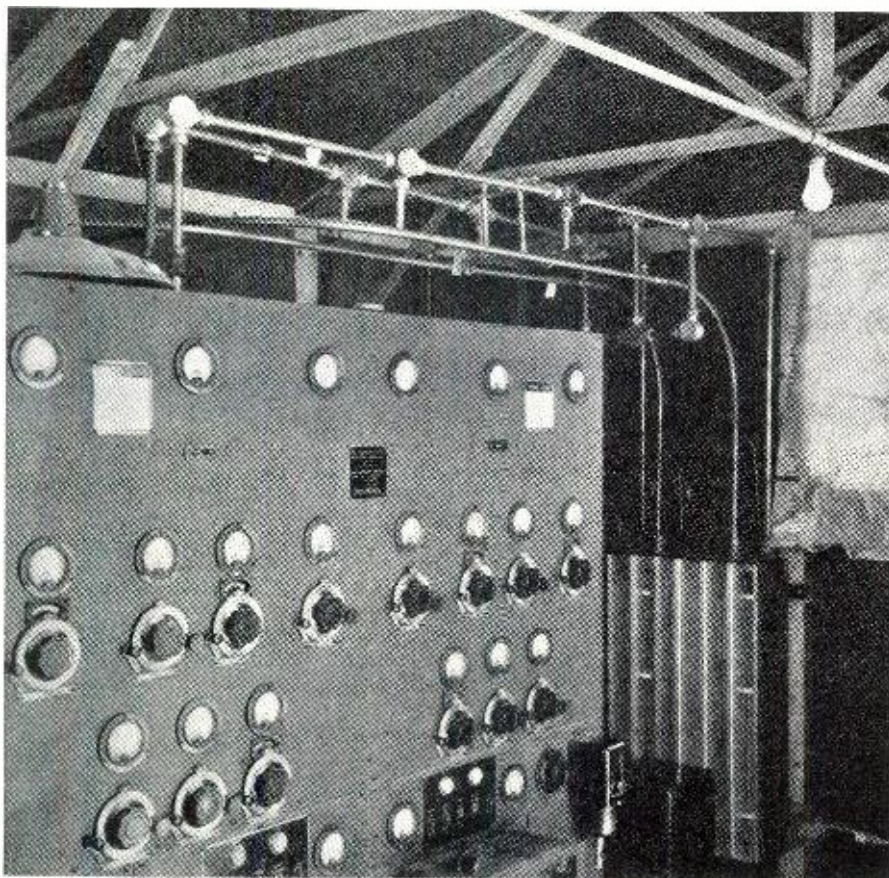

Transmitter and transmission line installation for the Chicago-New York UHF airway. Notice the locking devices on the frequency control dials.

tion; and no doubt UHF adaptors and converters will make their appearance but gradually disappear as did the high frequency equipment of yesteryear. The changeover will be gradual, will take time, and this author believes it will be given little thought after consummation, four or five years from now.

It is true that a large amount of UHF equipment is now being manufactured by various concerns for both aircraft and airport; but every piece turned off the assembly lines has a purchaser. Those purchasing the greater part of the equipment now manufactured are the Airlines, various Governmental agencies, private research concerns, and Foreign agencies. The equipment has been designed with rigid construction standards in mind, and it is thought that very few changes will be incorporated in the equipment manufactured now, due to the foresightedness of American engineers who have benefited from large scale research.

From time to time, we have all read articles expounding UHF theory, application, etc., as it concerns various services; but it is known by the majority that very few articles have been written with the aviation radio technician, operator, serviceman, student, etc., in mind. Of course, many papers have been presented to select groups or at gatherings of various associations, but those unable to attend these meetings were denied this information,

unless they were fortunate enough to read it in print.

In presenting this article, the author harbors the sincere hope that the information contained herein will provide a greater part of the "ground work" for the practicing aviation radio technician, the serviceman, operator, student, experimenter, and the general radio practitioner in acquiring the necessary knowledge to work efficiently with the new UHF aviation radio equipment for both air and ground operations.

The author has spent much time in research and has consulted various experts whose studies of the UHF situation have contributed much toward the advancement of this new mode of communication. However, it is realized that to cover every aspect of UHF aviation radio, it would take many volumes of printed material, but it is felt that, by stressing the important points of the subject under discussion and bringing out those details deemed essential, it is possible to present the situation in such a way so as to cover it in a generalized manner and still omit superfluous material.

It is assumed here that the reader now has some knowledge of mobile and fixed radio communication systems as used either in the police, general broadcasting, or aviation services. The radio amateur who has built his own equipment should have no trouble whatsoever in understanding the new UHF aviation radio setups.

Without a complete understanding of the rudiments of UHF wave transmission and reception, the average person will be at somewhat of a disadvantage when it comes to the study of equipment applications. It is necessary that one understand the underlying phenomena in order to cope with modern trends in equipment design, application, installation and operation. With this in mind then, we shall proceed with our main considerations.

General

The many applications of UHF for increasing flying efficiency and raising the safety factor in flying are amazingly unlimited. The advantages more than outweighing the disadvantages. To those who realize just a few of the technical considerations influencing their usage, a clear picture presents itself. What, with greater freedom from "night effect" or low range skip, readily controlled "straight line wave propagation," less interstation interference (especially when frequency modulation is used), greater station accommodation on more available channels, no wonder UHF is considered for the very important job of guiding and directing aircraft over the air lanes of America!

The UHF range in the radio spectrum is said to begin above 30 megacycles (mcs.) and extend into infinity. Frequencies lying above 30 mcs. are considered UHF but are usually spoken of as "microwaves."

Those frequencies assigned by the *Federal Communications Commission* (FCC) to the aviation services falling in the UHF bands start at 33,420 kcs. and end at 143,880 kcs. The 129-132 mc. band is used for airport traffic control work, superseding the low frequency of 278 kcs.; for radio range work, the frequencies of 63 to 125 mcs. is being used and considered. The frequency of 75 mcs. is used for marker beacon work.

Each band of frequencies presents its own transmission and reception problems, but even though each band has its marked peculiarities, these are easily controlled by properly designed and installed equipment. Too, certain of these marked peculiarities sometimes are utilized to full advantage. One example being in the use of the frequency of 75 mcs. for marker beacon operation, which exhibits proper "wave shape" when transmitted by a specially designed antenna system.

UHF waves are not reflected or refracted from the upper atmosphere as are the lower or medium frequency waves; and in order to utilize them effectively, the "band limitations" of the various available frequencies must be known. It is known, that certain bands in the UHF wave spectrum must be assigned to "specific" duty if best results are to be obtained. In amateur manuals, one will usually see the list of allocated bands; and opposite each band, one will see in part, the "limitations" of each. That is, what frequencies

(Continued on page 61)

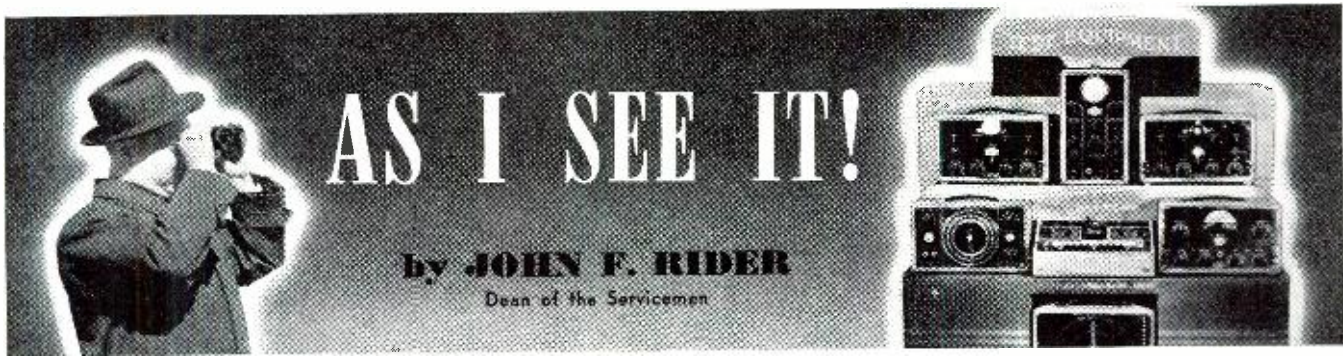

Set Dealers Doing Service Work

It may interest independent radio service shops to learn that many chain store set dealers who have not been seeking much service work in the past are now "hot-footing" after such business. Many are using canvassers drumming up as much service business as possible. This is not surprising considering the fact that the impending curtailment of new set production is going to dig into the revenue of these organizations. Of course there is little likelihood of service business offsetting the loss in new set sales, but every little bit helps.

To the independent man, this is important, for he cannot afford to lose what business he has and the increased business in store for him. He'll have to make every effort to compete successfully, for every radio set dealer who goes out after service business has a definite edge. To start with he may have sold the original receiver, hence has a more direct contact with the owner than the serviceman who must solicit the job as a rank outsider. As a rule his establishment is larger than that of the servicershop and better equipped financially. His name is better known for he has been a more consistent advertiser in local newspapers and other media which reaches set owners daily.

This calls for more active effort of a personal nature on the part of the servicershop owner. It may mean personal solicitation and more definite direct mail effort. . . . To say the least it is going to mean more sales work, but that's to be expected. . . . Competition which has not been very active in the past now is making strides—for it means survival. . . .

Test Equipment

MONTHS ago we wrote about test equipment. We forecast a shortage with meters as the primary item. Well, this shortage has developed and the difficulty is in getting meters. Again we tell servicemen, get what test equipment you need, for it will be more difficult to get them later.

Don't be surprised to see some change in test equipment design. Before this thing is over, it may be necessary to sacrifice accuracy and use various methods of indication other than meters. You may think that the suggestion to use magic eyes and calibrated voltage dividers, for perhaps 3" magic eye tubes with calibrated scales

laid across the screen, is crazy, but the whole world seems to be that way, so we're not overstepping any special boundaries.

After all, many measurements which servicemen make need not be more accurate than 10 per cent, so why not accept something which is capable of this accuracy, when that which everybody knows is better, is not available. . . . Maybe what we talk about won't come for a long time, perhaps a year, but mark our words, it's not as wild as it sounds.

GYP Radio Repairmen?

THE August issue of the READER'S DIGEST carries a story about radio servicemen in the United States, which every serviceman should read. It may not be possible to obtain a copy at the time this column appears, in view of the lapse of a month between the time that this column was written and the appearance of RADIO NEWS on the news stands but we hope that somehow or other every serviceman in America will be able to read about this investigation conducted by READER'S DIGEST, and absorb all the details given.

Inasmuch as these copies may not be available, we will give a general resume of what the author, Roger William Riis, had to say in his article.

Two investigators, a woman and a man, made a trans-continental tour of the United States and visited all forty-eight states. According to the July and August issues of READER'S DIGEST the purpose of this trip was to

investigate how automobile service shops and radio service shops behaved in their associations with the public. Since the radio servicing industry is not interested in how automotive repair shops behave, we will forget about the July article. In the August article the author states that during the travels of these investigators, they visited 304 radio shops spread throughout the forty-eight states, and each time, prior to the visit to the individual shop, the investigator created a minor defect in each radio set. One of these defects was to open a battery connection which, according to the author, was easily visible as soon as the back of the radio set was removed. Another kind of defect created by the investigators was to loosen one of the tubes in its socket.

Without describing in detail the individual experiences, it should be sufficient to mention the conclusions which were reached by these investigators, and which conclusions are presented by the author for consumption by the public. Essentially, it is that radio repairmen employ *dishonest tactics* to produce profit from the public's ignorance of the technical side of radio. This same thought is put into other words by saying that the radio repairman will gyp the public, if the public does not take proper precautions!

According to the author, of the radio shops visited and located in places of less than 10,000 population, more than 50% were dishonest; and in larger cities more than 65% were dishonest. The author claims that in New York and its metropolitan area, of the shops they visited, almost 90% of the men were dishonest. As the author puts it, of the 304 shops visited 64% of the owners were "in favor of gyppery."

In addition, the author makes reference to a radio school which one of the investigators attended, wherein, it is claimed, one of the instructors in no uncertain terms gave specific advice on how the radio repairman can cheat the public. This was supposed to be a private conversation between the instructor and the investigator, the latter appearing as a student.

Taking the article as a whole, it is in effect a broad indictment of the radio servicing industry, for if more than 60% of the men are dishonest and live by gyping the public, then a pre-

(Continued on page 52)



"To be honest with you—this is what I recommend for your set."

ULTRA-MODERN

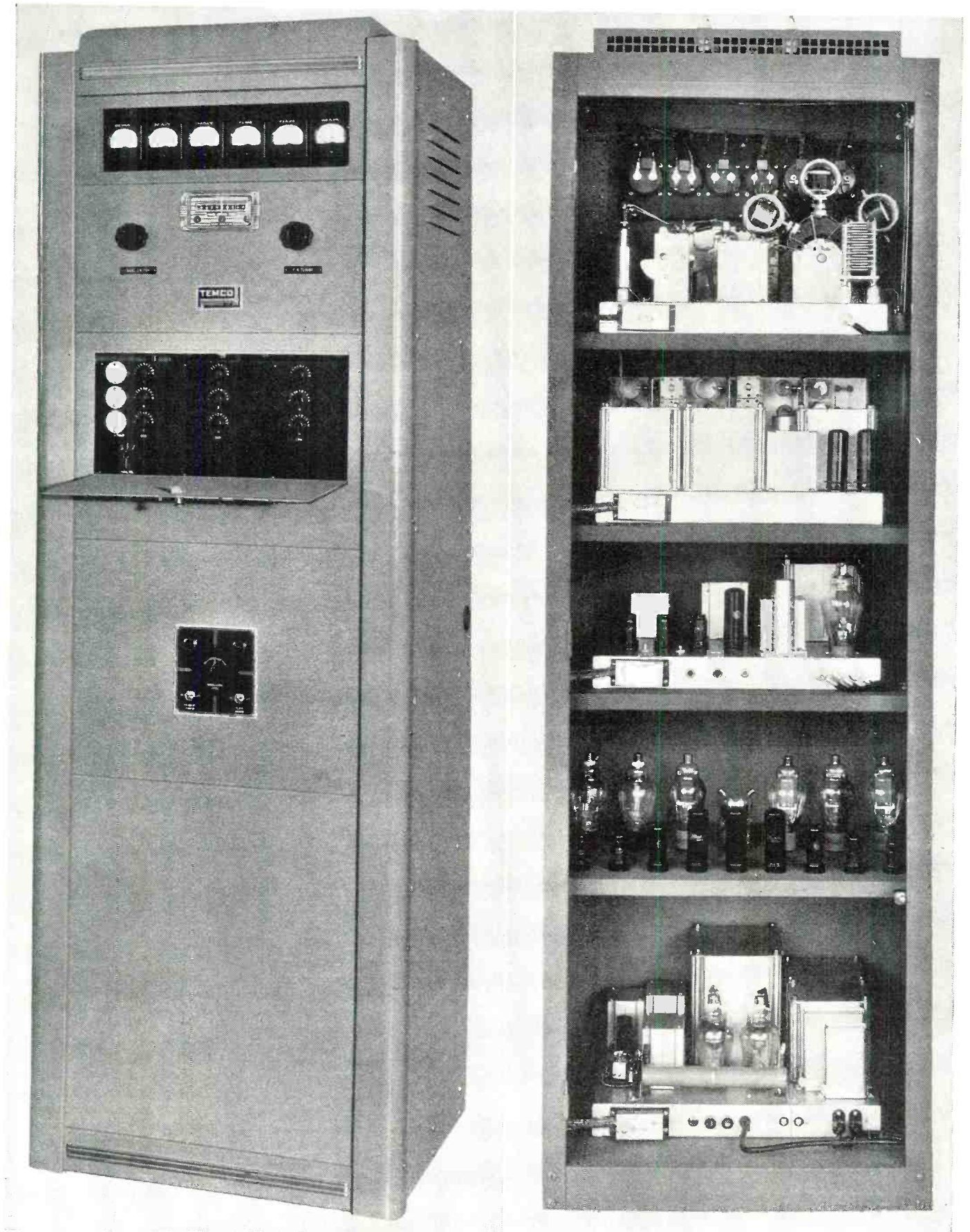

The TEMCO Model 250-G, 250 watt, three band radiotelephone and telegraph transmitter.

TRANSMITTER DESIGN

by **MORTON B. KAHN**

President, Temco

Advanced engineering is found in this efficient transmitter, which includes some novel features that may be added to the "Ham" rig for improved performance and greater flexibility.

EVERY now and then a transmitter of unusual design makes its appearance. Such is the new Temco Model 250-G band switching radio telephone and telegraph transmitter. It has many outstanding features which should prove of interest not only to the commercial operator but to the amateur as well. The entire assembly is built and designed around standard parts easily obtained and, inasmuch as each section has been constructed as a separate unit, will offer suggestions to the amateur so that he might take advantage of these features in existing equipment. The simplified circuit drawings show important wiring.

The specifications for this transmitter include the following:

FREQUENCY CHANGE METHOD

Plug-in pretuned units in crystal oscillator, buffer and intermediate amplifier stages, selection controlled by front of panel band switch. Plug in coils into turret arrangement with band switching from front of panel for the final amplifier.

RF TUBES

One 6J5, one 6AG7, one 815, two 812s.

RECTIFIER TUBES

Two 866As, two 5T4s, one 5W4 bias rectifier.

AF TUBES

Two 6SJ7 tubes, one 6C5, one 6L6 two 812s.

FREQUENCY CONTROL

Direct crystal control with provisions for three crystal holders.

MODULATION SYSTEM

High efficiency class B plate modulation with peak limiter.

AUDIO FREQUENCY RESPONSE

Uniform within plus or minus 2 db from 80 to 8000 c.p.s.

AF AMPLITUDE DISTORTION

Less than 10% r.m.s. total harmonics at any modulation level.

RESIDUAL NOISE LEVEL

More than 40 db below 100% modulation.

KEYING SYSTEM

Cathode keying of the crystal oscillator.

RF OUTPUT IMPEDANCE

60 to 500 ohms by means of variable link coils built into each final tank coil.

POWER SOURCE

115 volts 50/60 cycles single phase. A very efficient method of band

switching is incorporated in the r.f. section, which includes the crystal oscillator, buffer and intermediate amplifier stages. Plug-in units are featured in the crystal oscillator. Note the three *Hammarlund* condensers mounted one above the other on the panel adjacent to the three *Millen* crystal sockets. The combination of crystal, coil and condenser is pretuned in the oscillator stage.

A front-of-panel band-switch is used for selection of the frequency on which the transmitter is to operate. A similar arrangement is used in the buffer amplifier. All of the coils are wound on ceramic forms, keeping losses to a minimum. These may be seen mounted in such a position that they may be plugged into the receptacles provided on the insulated baffle shields which are located between each stage. Further stability is provided by using split stator condensers in both the buffer and intermediate amplifier stages.

The selector switch for each stage is built onto the baffle and is located

Three channel band-switching exciter unit has unique method for changing frequency.

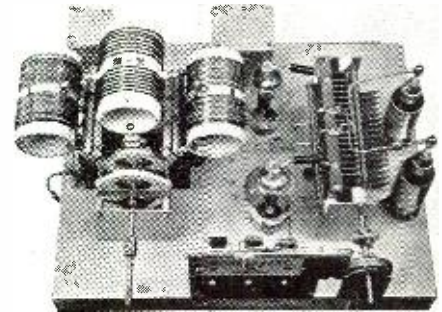

Above: Push-pull 812's used in the amplifier stage. Below: Under side of three-band exciter chassis.

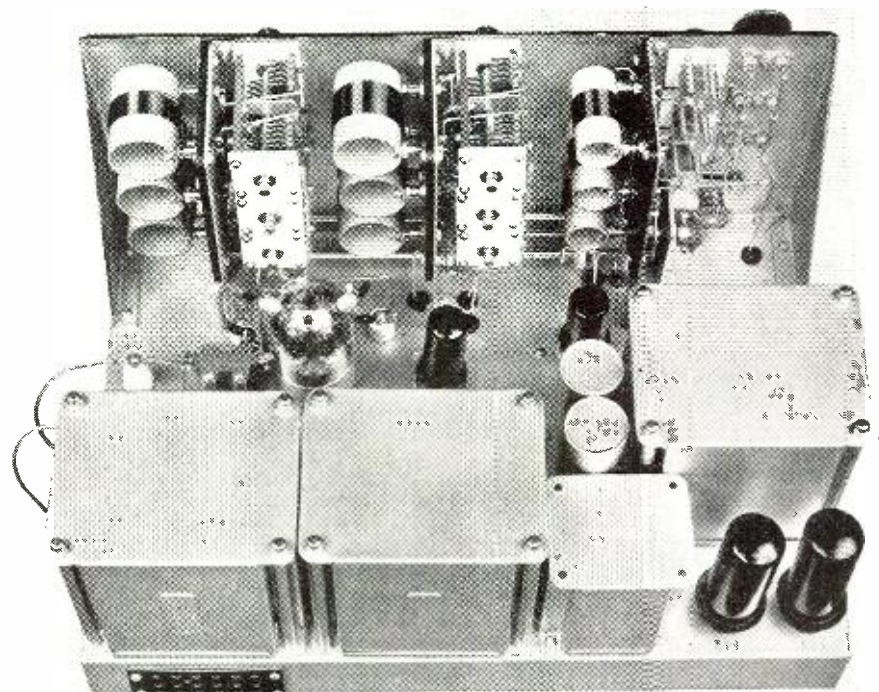
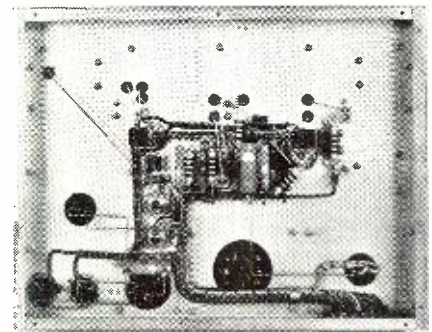

directly under the condenser-coil assemblies. A common shaft runs through these baffle shields and terminates at right-angle gear drive, which may be seen below the crystal sockets. This method of band-switching provides extremely short leads with a constant high order of efficiency. All of the wiring is done with solid tinned copper bus and, where necessary, the leads pass through the chassis through rubber grommets to prevent shorts.

The new 815 r.f. tube may be seen mounted directly back of the intermediate tank condensers. The high voltage mica by-pass condenser is also mounted as close as possible to the tube to avoid long circuit return. Feed-through insulators are provided, where necessary, to pass r.f. connections to the underside of the chassis.

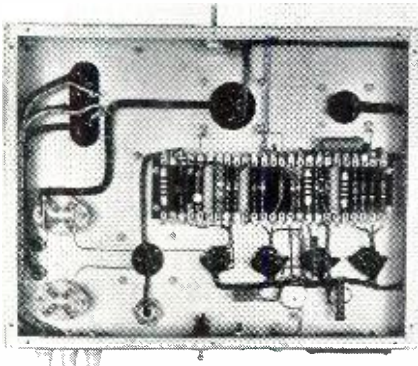

Underside of the speech amplifier.

The complete power supply for these initial stages is located on the same chassis along with the r.f. components. A pair of 5T4's serve as rectifiers and these may be seen mounted in the rear corner on the chassis.

A bakelite panel is placed over the metallic front piece and identification and dial scales are etched on this bakelite piece. The entire unit mounts within the *Par Metal* cabinet in back of the main panel of the cabinet. A door is provided as may be seen in the illustration, so that this panel is completely sealed when the door is closed. This keeps dust and other foreign

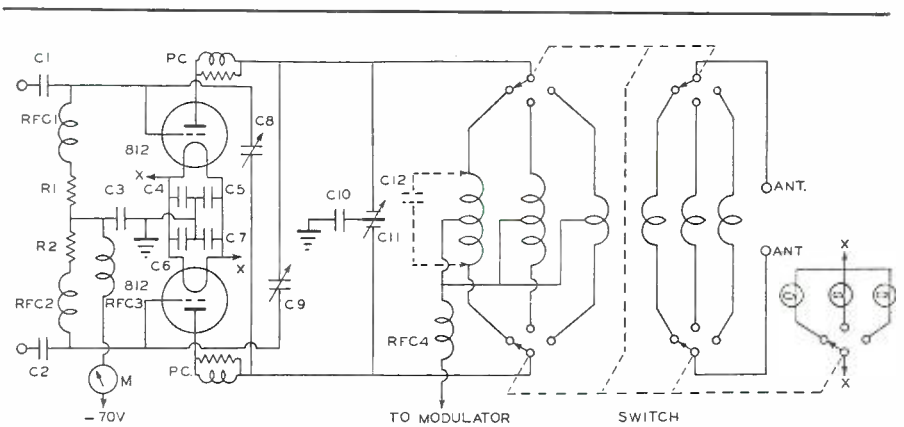

C₁, C₂—0.0025 mfd., mica Sangamo
 C₃, C₄, C₅, C₆, C₇, C₁₀—0.02 mfd. mica, Sangamo
 C₈, C₉—Neutralizing condensers, Millen 15006
 C₁₁—110-110 mmf. tank condenser, Cardwell XG-110KD

C₁₂—100 mmf., padder for 160 meters, Cardwell
 RFC₁, RFC₂, RFC₃—R.F. chokes—Johnson
 RFC₄—R.F. plate choke, Johnson
 PC—parasitic choke
 M—0-100 Ma. meter, Triplett 227A

particles from entering into the cabinet at this point and also prevents "tinkering" of the controls after they have once been set for proper operation.

The r.f. tube line-up is as follows: 6J5 crystal controlled oscillator; 6AG7 frequency doubler or buffer; 815 push-pull intermediate amplifier; and the two 5T4 rectifiers.

Final Modulated Amplifier

Push-pull 812's are used in the final modulated amplifier. This unit is located on the top shelf within the cabinet. A specially designed turret assembly is utilized for the tank coils so that complete band-switching may be had. When necessary, a fixed air condenser is used to afford a proper L.C. ratio, and this may be seen mounted in the right rear corner of the amplifier chassis. Neutralizing condensers are located at the opposite side, on top of the chassis, directly adjacent to the tuning condenser. Only two control knobs are required for operation of the final amplifier—one to set the bands and the other to resonate the plate tank circuit. A multiple connector and plug is used on this section so that it may be removed easily for alterations for servicing, if required.

Of particular interest is the slide-rule dial which may be seen in the center of the amplifier panel. This is connected to the P.A. tuning knob and indicates the band on which the transmitter is set to operate.

A complete insulated meter panel is provided to include complete facilities for the reading of various potentials and currents throughout the tuned circuits. Reading from left to right, facing the transmitter, are the oscillator plate, buffer plate, I.F.A. plate, P.A. grid, P.A. plate, and modulator plate current meters. This panel is recessed and takes on a most pleasing appearance to the observer.

All r.f. stages are completely band switching for any three pre-determined bands and consist of separately tuned tank circuits in the oscillator, buffer and intermediate amplifier stages. Variable link coils are built into each amplifier tank coil and when once adjusted for proper coupling, need no further attention. Inasmuch as the loading will be different for each band, this feature will be appreciated by those who have had to retune the complete antenna system when such band change-over was made.

(Continued on page 41)

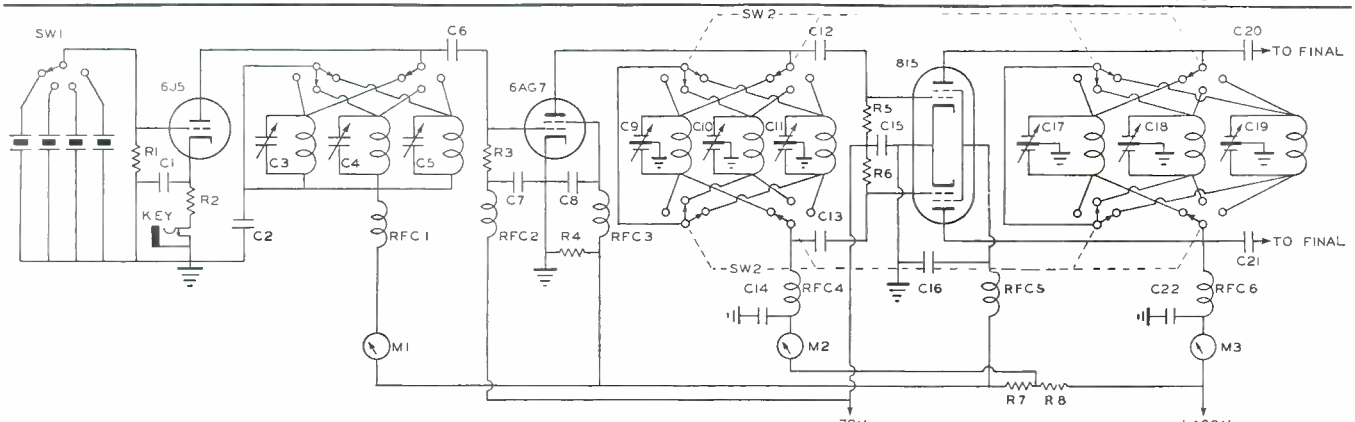

C₁, C₂, C₇, C₈, C₁₄, C₁₅, C₁₆, C₂₀, C₂₁, C₂₂—0.02 mica, Sangamo
 C₃, C₄, C₅—100 mmf. var., Hammarlund HF100
 C₆, C₁₂, C₁₃—0.0005 mfd. mica, Sangamo
 C₉, C₁₀, C₁₁, C₁₇, C₁₈, C₁₉—100-100 mmf. var.
 R₁—100,000 ohms, 1 w., Erie

R₂—500 ohms, 1 w., Erie
 R₃—50,000 ohms, 1 w., Erie
 R₄—5,000 ohms, 10 w., Ward-Leonard
 R₅, R₆—25,000 ohms, 3 w., Erie
 R₇—1250 ohms, 10 w., Ward-Leonard
 R₈—2250 ohms, 10 w., Ward-Leonard

RFC's—250 Ma., RF chokes, Hammarlund
 SW₁—Crystal switch, Centralab
 SW₂—Special band switch, Centralab
 M₁—0-25 MA meter, Triplett 227A
 M₂—0-50 MA meter, Triplett 227A
 M₃—0-250 MA meter, Triplett 227A

BENCH NOTES

by **ROBERT KENDALL**
Service Manager, Indianapolis, Indiana

Portable Battery Testing

By the average serviceman the 1,000-ohm per voltmeter has been accepted so long as a standard piece of equipment, that it may come as a mild surprise to find it not as generally applicable as he thought. When testing the dry batteries of portable receivers, results are apt to be worthless, if only the light load of the 1-mil meter is applied.

Ordinarily the batteries are disconnected, and removed from the case to facilitate testing, and the 1,000-ohm per volt meter may be used with informative results if sufficient resistance is shunted across the battery to approximate the normal load by the tubes. The following *shunt* values are suggested by the *Burgess Battery Company*:

For 1.5-volt batteries: 6 ohms.

For 45-volt batteries: 4500 ohms.

In practice it will be found that these values are not critical, anything from 5 to 10 ohms will be suitable for the 1.5-volt cells, and 2500 to 5000 ohms will load a 45-volt battery sufficiently to determine its condition.

Tubes and Service

WE were giving our tube shelves a thoughtful *gander* recently, with a view to adding a half dozen new types to an already cumbersome stock, when our eye fell upon a couple of boxes filled with "trade-in" tubes which we find useful in handling cheap repair jobs, where all costs must be kept down to make a profit. On checking up we found there were approximately two hundred of these tubes on hand, and we could not help but reflect on our early days in radio when as many as five spare tubes would have been an undreamed-of affluence; and compare the nonchalance with which we dumped out these "trade-ins" on the bench for inspection, with the tender care we lavished on our first tubes.

Our first radio tube was bought sometime in the early 20's, about the time KDKA went on the air, when a local distributor advertised the astounding fact that fifty radio vacuum tubes would be placed on sale at 9 o'clock the next Saturday morning. Garnering the required nine bucks, and arriving on the scene at 8:30 a.m. we found about thirty men already in line, and in due time received a carton

about 8" long and 3½" square containing the newest scientific marvel.

Hastening home we placed our prize well in the middle of a large table, and after unwinding about two or three yards of cotton padding, beheld with mingled pride and awe our first own radio tube. This tube was a brass-based UV 201, whose filament drew 1 ampere, and lit up with a brilliance that was probably responsible for a later gag about the Scotchman who complained that the little lamps in his radio did not give enough light to read by.

Some time afterwards the UX 201A was developed, reducing the filament current to .25 ampere (thus losing the Scotch trade entirely) and as late as 1926 the serviceman had little to worry about as far as tube types were concerned, as the ones in common use were all triodes and with the addition of some UV 199's, a few WD-11's and perhaps a 210 for the occasional plutocrat, the radio shop was adequately stocked to take care of all normal demands.

The introduction of the a.c. tubes naturally caused much excitement and some confusion among the radio men, which must now appear as laughably trivial, in the light of our experiences of the past few years. The development of the screen-grid tube marked a definite turning point in the design of modern radio tubes, and since that time extra grids have been inserted with a free hand, and new styles in radio tubes are turned out as fast as new styles in women's hats, with the same tendency to make the observer somewhat dizzy.

While the tube manufacturers



"Quick! Gimme a tube of Jiffy tooth paste. The radio announcer says I can't be without it for another minute!"

themselves admit that at least two-thirds of the types now listed are superfluous, and the multiplicity of types presents a serious problem to the service shop, in the way of economically maintaining an adequate stock; the tubes themselves are, without question, a vast improvement over the low gain triodes of the earlier days. The major advantages of modern tube design are represented by the high-gain, stable pentode amplifiers, and the almost fool-proof converter or mixer tubes, that efficiently solve a problem that perplexed many a designer and home-constructor in the early days of the super-het.

That this was a problem is evident to anyone who reviews the many circuits and expedients that were once used to couple the so-called "first detectors" and the oscillator. In early model superhets, the method of obtaining such coupling was a matter of some importance, and it is doubtful if any man who has not had to battle with this problem can fully appreciate the simplicity and efficiency of the modern converter tube. For that reason we are inclined to think that many men accept the multi-grid converters as a matter of course and regard them as all alike, whereas there is a distinct difference between types, and a brief discussion on that point may be of interest.

Modern Mixers

AT present the mixer tubes commonly used are represented by the following types: the 6A7, 6A8, 6J8G, 6K8, and the 6L7. Of these the 6A7 is the most common, representing the first pentagrid converter tube released, and the 6A8 is practically the same tube except for its metal envelope and octal base. Electrically these two are much the same, and have the same limitations—a loss of efficiency at frequencies above 10 megacycles, and a marked tendency to "lock-in" as well, rendering proper alignment of ganged condensers difficult and uncertain at 15 or 16 megacycles.

This difficulty is often avoided in commercial receivers by inserting a resistance of 50 ohms in the r.f. grid lead. When operating shortwave receivers, such as the "Hammarlund All-Star" for instance, where the oscillator and r.f. sections are separately

(Continued on page 46)

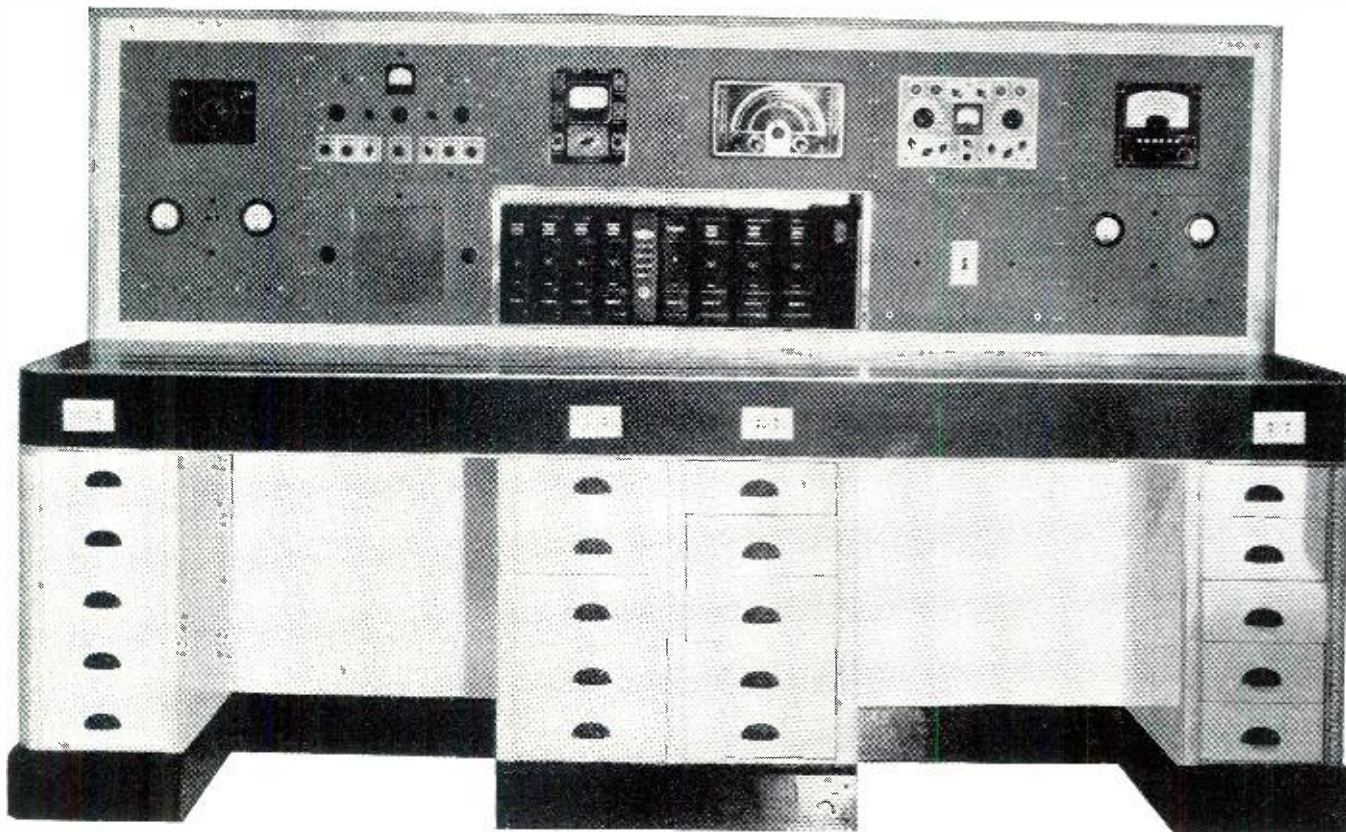

Neat in appearance, and fully equipped, is this up-to-date workbench of Louis K. Sandor, Piqua, Ohio.

MEASUREMENTS in Radio Servicing

by **WILLARD MOODY.**

New York, N. Y.

Many problems in radio servicing are discussed by the author, and means for proper testing procedure are explained thoroughly.

THE measurement of tube *quality* is probably the most important procedure in everyday radio servicing, since the tube determines to a great extent the performance of the set. If there is a tube failure in the rectifier circuit, the set will not play at all. If an output tube has weak emission (low electron flow) the tone will suffer. When a short circuit develops in any tube, circuit constants may burn out or hum will be evidenced in the loud speaker's output.

With the present development of the tube industry and meter manufacturing, it is unwise and expensive to build tube testers in the shop, since they cannot even approach the manufactured product in point of accuracy, appearance and general performance. Further, the complications of modern tube testers are such that special training is required to handle all but the simplest obvious repairs. For that reason and others, the serviceman would do well to let the tube tester

alone when it become inoperative and to send it to the factory or factory representative in the interests of real economy and accuracy. In consideration of the above, no mention or circuit will be shown of a tube tester. All that is necessary is to follow the manufacturer's instructions and to use ordinary good care and common sense. The same advice applies to complicated volt-ohmmeters, signal generators and oscilloscopes.

The construction of simple ohmmeters, voltmeters or even the vacuum tube voltmeter is not beyond the ability of the average man with little time to spare from straight service work. As a matter of fact, it is frequently an advantage to build such equipment in order that money may be saved.

Probably the most useful of service instruments is the ohm-meter, consisting of a sensitive low range milliammeter or micro-ammeter with suitable resistors and batteries. The meter

scale is calibrated directly in ohms. Many manufacturers have on the market a number of kits for just such purposes. The best will have a large meter, 3-inch diameter is good, with a sensitivity of 1 milli-ampere or 500 micro-amperes. More sensitive meters are available but are apt to get out of order if handled roughly. The 0-1 milli-ampere model is standard and will serve well on service calls in the home.

For the shop, where the meter is mounted on a test panel and is not subject to mechanical shock, a more sensitive movement is convenient. The higher sensitivity will cause less circuit loading and give more accurate readings. A meter with a clear scale of 0-1 and 0-5 will be easily read, rather than a number of confusing scales. An ohms scale should also be included on the meter face. For reading higher voltages or currents, ciphers or zeros are simply added mentally. Thus 0-1 would be 0-100, 0-1000 and

0-5 would be 0-50, 0-500. The same applies to the ohms scale, 0-10-100-1000. A simple volt-ohmmeter circuit which will enable the serviceman to find the trouble in the majority of receivers, is shown in Fig. 1:

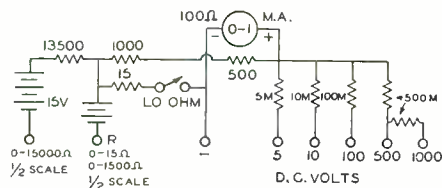

Fig. 1

A Triplett 3 inch diameter meter is used. The ohmmeter reads 15 ohms center scale on the closed switch position. For higher ranges, the switch is left open. With a 15 volt battery the range is extended to 15,000 ohms half scale and 500,000 at the extreme end. A 150 volt battery or power pack would extend the range to 5 megohms, with suitable series resistance.

A good commercial instrument, using a high sensitivity meter, may have a range as high as 10 megohms on ordinary, lightweight batteries. However, good results may be had with the circuit shown.

By means of a high voltage supply, using an 80 rectifier, as shown in Fig. 2, a high range ohmmeter or leakage tester can be constructed. A good paper condenser will cause the meter needle to "flick" upwards and then

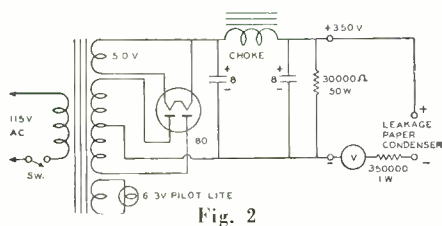

Fig. 2

gradually recede to zero. If the condenser is "open" (zero capacity) no meter needle movement will be obtained. Condensers from about .001 to 1 mfd. may be tested. Small mica condensers will not have enough capacity to make the meter needle move on "charge," which is when the current is flowing into the condenser. Mica condensers may range from 50 mmf. to about .1 mfd. in capacity. If they are leaky the tester shown will indicate the fact. It will not indicate "charge" however.

For testing electrolytic condensers, put the ohmmeter on the middle range of 1500 ohms at half-scale. Condensers from 2 to 30 mfd. may be checked by watching the meter needle flick upwards as the condenser takes the charge from the battery in the ohmmeter circuit, then as the condenser discharges the needle of the meter returns to a point near, but not quite zero. Comparison may be made with two or three brand new condensers to get an idea of the way that the circuit operates. A leaky condenser will have a high steady current; an open condenser will not charge up.

Assuming that the serviceman has

the instrument shown, or that he has purchased a commercially made volt-ohmmeter of the better grade (\$15 or more), a start may be made as to when and where to make measurements on a receiver. The first and initial step should be to check the tubes carefully, using a good and accurate tube tester that is capable of showing up leaky or weak tubes. If the tubes are all right, as far as leakage or weak emission are concerned, they may be checked further if the set is operating by simply tapping with a pencil or bakelite rod. The volume control should be turned up and the set dial adjusted for off-station tuning.

Background noise will be heard if the receiver is operative. Tapping the tubes one by one will locate noisy tubes, as the background noise will be increased or a separate and distinct

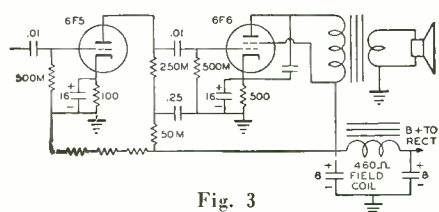

Fig. 3

noise will be heard. Occasionally, this may be misleading, unless carefully done, since tapping the tubes will cause other parts of the receiver to vibrate. In its sensitive condition, off any station and, volume control at maximum, a loose connection or the antenna rubbing against the chassis may cause noise. A loose tube shield or pilot light bracket, a defective volume control or loose tuning condenser mounting, any electrically bad connection might be troublesome and lead to false conclusions.

The point is to confine the vibration test to as local an area as possible, by using the minimum amount of vibration tapping or lead pulling, to reduce transmission to other parts of the receiver. Many intermittent or puzzling troubles may thus be localized by careful inspection, whereas instruments, even expensive Channel Testers, might be valueless.

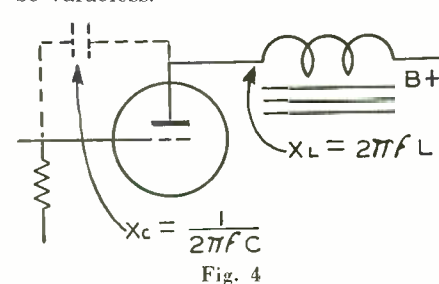

Fig. 4

In this discussion it will be assumed that the reader has access to a tube manual giving all the pin connections of the tubes with which he has to work. Such manuals are available from RCA, Sylvania and other prominent manufacturers.

If the receiver being tested is an a.c. model with a power transformer, the set hums, does not play and has a pilot light that is working, the trouble one

would assume would be somewhere in the filter system. A typical layout is shown in Fig. 3.

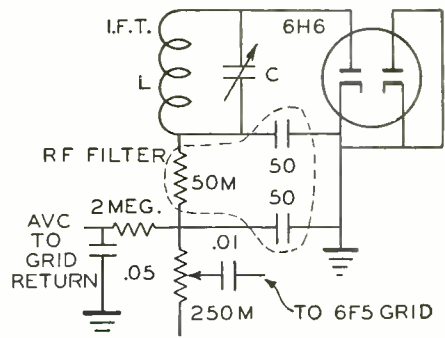

Fig. 5

If the first filter condenser opens up partially, the B voltage will drop due to the action of the poor condenser not charging up on the input of the pulsating rectifier. Hum may be heard in the loud speaker, and still the set would not be getting enough B voltage to operate. A shunt condenser of 8 mfd. from a test panel may be placed across the suspected unit. The set will then suddenly "pop" into action, the hum will be gone and the tone will become normal.

If the tube had been pulled out of its socket while the receiver was operating, and the hum had stopped, the indication would be that hum cur-

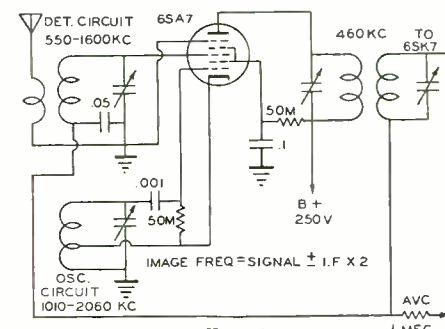

Fig. 6

rent was flowing through the transformer winding in series with the 6F6 plate. If a loud click was heard, either the second 8 mfd. condenser, from screen of the tube to chassis, or the tube itself would most probably be leaky. The fact that a loud click was heard would mean normal or even excess tube plate current. That in turn would signify normal plate voltage. A test condenser of 8 mfd. could be shunted across each suspected condenser, and the effect on receiver performance noted. When an open condenser across the cathode resistance in the 6F6, or other similar circuit, is bypassed by a good condenser, the volume will increase and the tone becomes clearer.

If no click were heard when the 6F6 was pulled out of the socket, the best thing to do would be to make a resistance test with the ohmmeter, from number 3 and 4 prongs to chassis. The plate and screen circuits might be shorted. A short through the second 8 mfd. condenser would indicate low resistance from the screen of the 6F6

to ground. The plate resistance, under such conditions, if the screen is shorted to ground, would be slightly higher due to the d.c. resistance of the transformer winding in series with the plate.

Very often, cases are encountered where the .001 mfd. condenser from 6F6 plate to cathode is shorted. This burns up the cathode resistance, as then too much current flows through it. The two parts have to be replaced. An ohmmeter test immediately indicates the trouble.

The bias across the cathode resistance may be checked by connecting the voltmeter from cathode to ground, positive terminal going to the cathode. The grid will be negative with respect to the cathode since there is a drop across the 500 ohms between the two. Usually this will be around 15 volts for the 6F6. The exact bias will depend upon plate, screen, heater and grid voltages. Grid voltage is the a.c. input which swings the grid to zero on positive peaks and to twice the negative bias on negative peaks.

If the 6F6 tube is leaky, or if the coupling condenser between 6F5 plate and 6F6 grid is leaky, grid current may flow in the 500,000 ohm resistor. If the condenser has a low leakage resistance, the grid may be positive. If the tube itself is leaky, the grid may

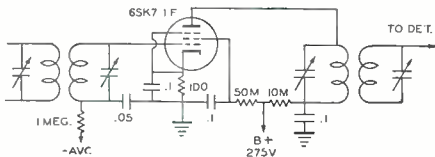

Fig. 7

be positive with respect to ground. A 1,000 ohms per volt meter generally will not show up the condition, unless there is practically a short circuit in the coupling condenser. A 5,000 or 20,000 ohms per voltmeter, or a d.c. vacuum tube voltmeter will more readily show grid current.

Assuming that the 6F6 stage is operative, as evidenced by the fact that a voltmeter applied to the 6F5 plate causes a click in the loudspeaker, or that a click is produced when the 6F5 is pulled out of its socket and, further, that touching the grid connection of the high gain audio tube, the 6F5, produces no loud disturbance, it is safe to assume that the trouble lies in the 6F5 stage. A plate voltage test will show about 30 volts with a 1,000 ohms per volt meter, about 60 volts with a 5,000 ohms per volt meter and about 95 volts with a vacuum tube voltmeter if the tube is drawing plate current. A tube with a "free grid," which is an open grid circuit, will have very little plate current. This will result in a plate voltage that seems to be, not only high enough, but too high.

Most frequently, in any irregularity of the plate circuit, the .25 decoupling or by-pass condenser will be either leaky or shorted. It may be tested by removing one lead from the circuit

(Continued on page 51)



by ALFRED TOOMBS

Good News for Servicemen

THERE has come, in the last few weeks in Washington, a marked change in the official attitude toward radio. And in this change, there is good news for one and all.

For Washington has decided that radio, after all, is a pretty important item in this emergency and this decision means that a lot of hardships and restrictions which were threatening the field have been cleared away. Servicemen will find particular cause for rejoicing in the news from the Capital.

Early this summer, the *Office of Production Management* began to reshuffle its priorities lists in an effort to make sure that every ounce of aluminum in the country would go where it would do the most good. The *OPM* moguls decided that radio was just about as non-essential as an article could be and gave it a priority rating equal to tooth-paste tubes. This action left the manufacturers—and the servicemen—out on the end of a very thin limb.

President Knowlson of the *Radio Manufacturers Association* warned that a critical situation was developing. Not only would the manufacture of new sets be virtually stopped, but it would become difficult to repair the ten million which go wrong annually—because "if the set business is stopped, part manufacturing will be too." To the rescue of the *RMA* came Chairman Fly of the *FCC* to echo the sentiments. Radio, Mr. Fly contended, was an essential in time of emergency because it represented the fastest means of getting news and warnings to great masses of people.

What the Chairman of the *FCC* had to say made a great deal of sense to his fellow New Dealer, Leon Henderson, who runs the *Office of Price Administration and Civilian Supply*. The wheels began to grind and presently, radio was restored to the charmed circle of essential items. The manufacturers did not by any means win permission for "business as usual" but they did get some concessions—and some good advice. Here's the way it worked out:

The *Price Administrator* decided that there were certain essential commodities and utilities which must be kept in a state of repair. Commercial radio was among these. It was ruled that these industries should get preference in obtaining material.

"Materials and equipment necessary for emergency maintenance and repair of facilities in the above classifications shall be allocated to such use prior to all other civilian requirements and prior to defense requirements to the extent consistent with the defense program as determined by the *Office of Production Management*," it was ruled.

The *RMA* received assurances that this meant that manufacturers would receive material from which they could make replacement parts. The hope of the Henderson office is that the manufacture of new sets can be slowed down gradually for a time—while at the same time the flow of replacement parts is kept steady. The manufacturers were advised to go after defense orders and the *OPM* began to bring pressure on the big manufacturers, who have received most of the defense orders, to sub-contract some of their work to smaller companies, which might otherwise be forced out of business by the shortage of materials.

The new order should leave servicemen on top of the heap. The Government is determined that civilian radio shall be maintained. Likewise, the Government is restricting ma-

terials which would be used in manufacture of new sets—while making materials available for repair of sets now in use. It looks like the green light for servicemen.

But Washington's new-found interest in radio is not confined to its commercial civilian aspects. As military preparations increase, authorities are finding that they must call more and more upon the trained radio men to fill important gaps. And Washington is finding that there aren't quite enough to go around.

That situation was reflected in the *FCC* order lifting the six-month experience requirement for operators in the *Merchant Marine*. This action is temporary and when the emergency has passed it is planned to revoke the rule which waives the experience requirement. The shortage of sea-going operators was getting acute and the action permits the Government to use the reservoir of newly trained operators turned out in *Maritime Commission* schools.

The Army itself has had to overcome a serious shortage of radio men. The draft failed to produce as many hamis as was expected—to be exact, the Army found that it got 15.3 less radio specialists than it needed. To make up this shortage, radio schools have been going at full blast at *Fort Monmouth*—for the *Signal Corps*—at *Scott Field, Ill.*—for the *Air Corps*—and at *Fort Knox, Ky.*—for the *Armored Force*. The first officers school for radio men since the World War is training its first class of candidates now at *Fort Monmouth*.

Because of the need for radio operators with the field services of the Army, it is planned to bring in some civilians to handle routine communications work—thus freeing soldiers from these jobs.

In addition, the Army is trying to find 500 qualified radio men to handle the new system of radiolocators which are going to be set up on sentinel duty around the United States. These radiolocators are similar to those in use in Britain. They are being set up along the nation's borders and on the Atlantic and Pacific outposts.

Applicants for this branch of the service must be graduate electrical engineers with radio experience, or electronic physicists, unmarried and without dependents, physically qualified and between the ages of 21 and 36. They must agree to serve outside the Continental United States, if necessary—which means they may be sent to one of the new Atlantic bases, to Alaska, Hawaii or the Philippines. Men who are qualified will be given commissions in the Army and the posts are open to men already in the Army under the Selective Service Act. The War Department has representatives travelling through the country, interviewing prospects for this important service at present. But where they expect to find 500 men for the service with the qualifications they demand, only the War Department knows.

Meanwhile, the *Defense Communications Board*, which is charged with making plans so that everything will be in apple pie order in the radio field when things get tough, is looking over the country's reserve of men and equipment very closely. The *DCB* has been doing some mighty planning, trying to shape up a communications system so well organized that it would be impossible to disrupt it.

Gradually, the *DCB* is working toward establishment of an elaborate national series

(Continued on page 42)

Theory and Practice of Disc Recording

by OLIVER READ

Part One of a new series designed to provide a complete course in the art of disc recording.

THE art of home recording will soon pass from the "novelty stage" into the more advanced stages which will permit longer playing time, greater range of fidelity, less turntable rumble, wow's, and other factors that have been present in the average recording equipment. The situation may be compared to the early days of amateur radio. The equipment was very crude compared to modern station setups and improvements were made in parts and accessories until, finally, results were assured the operator almost any time that he chose to operate his equipment.

Recording, in general, has been largely a matter of "hit-and-miss" procedure. Results have been disappointing to the average person and his interest has been weakened because of the inconsistency in turning out satisfactory records. Some do not concern themselves with *fidelity*, but are content to get by with whatever results that they may get and be satisfied with anything that sounds like the original, even though this may be only a "reasonable facsimile" and not a true reproduction of the original sounds.

One of the principal disadvantages of the typical home recorder is the short playing time that may be had from a record. Most of these recorders are limited in capacity to a 10" disc. That means that only a minute or two is available for the subject on one side. That is perfectly satisfactory for the person who confines his efforts to making records of someone's voice as a novelty. What about those who are eager to record musical selections that take several minutes for completion? The answer may be found by analyzing the situation and by applying certain principles that are not known by the average recordist.

The more serious-minded recordist will realize that in order to attain maximum results he must have the proper equipment. We will, in later installments, show many types of units that are suited to the class just mentioned. They are capable of giving "more minutes per dollar" than the more popular machines and possess certain refinements not found in the inexpensive recorders that are used in the average home.

It is not necessary to spend a lot of money in order to take advantage of the better types, nor does one need more costly discs. The main requirement is a thorough knowledge of the *technique* required for the making of good records. We will show how to apply the proper theory and application so that this may be accomplished properly.

It is first necessary that the prospective recordist understand the fun-

damentals of sound and motion in order to appreciate the recording procedure. Certain technical terms have been allotted to the recording art and these will be covered as the series moves along. The important subjects will be covered in proper order so that the layman may have a complete course of instruction in the art of recording. The following list of terms are used commonly when referring to recording in general and should be studied:

MICROPHONE—that changes sound waves into electrical currents.

AMPLIFIER—having the ability to increase the electrical sound waves in power.

SPEAKER—which changes the amplified sound waves back into mechanical motion.

CUTTER—the "engraving tool" of the assembly.

CUTTING STYLUS—the recording needle especially made for the purpose.

PLAYBACK NEEDLE—commonly called a "phonograph needle". Used for playing the record.

PICKUP—Used to pick-up *mechanical* vibrations and to transfer them into *electrical* currents.

VOLUME INDICATOR—a visual indicator of volume of sound. Used for correct cutter operation and to prevent too much power from being used to the cutter.

MONITOR—The use of a loud speaker or pair of phones to listen to the recording procedure. An aural indicator.

TURNTABLE—A heavy balanced table on which the disc revolves.

FEEDSCREW—Used on recorders to set the horizontal travel and space between grooves.

VERTICAL DAMPER—Used to absorb any up-and-down motion of the cutting head.

RECORDING LEVEL—refers to the amount of audio power driving the cutting stylus.

TONE CONTROLS—Similar to those found on radio sets to adjust tone as desired.

GAIN CONTROL—Used to set the volume of sound as it passes through the amplifier.

SCRATCH FILTER—A tuned-trap designed to absorb the audio scratch.

CHIP—Referring to the material that is cut from the disc.

DISC—A record blank. (Either with or without pre-cut grooves.)

GROOVE—The cut "valley" that is "chiseled out" by the cutting needle.

WALL—The sides of the groove.

CUTTER TENSION SCREW—Used to adjust the depth of cutting.

LAND—The uncut portion between grooves cut in the record.

MASTER—A specially prepared over-size disc used when duplicates are to be pressed. (This is a wax disc and is treated before processing.)

DUBBING—The making of a duplicate record.

Wows—The unsteady note resulting from variation in turntable speed.

ECHOS—A "repeat effect" caused by overcutting of adjacent grooves.

PRESSINGS—The technical nickname of regular records purchased from stores.

STANDARD SPEED—This is commonly used on all but a few instruments (78 rpm).

DUAL-SPEED—Includes both standard (78 rpm) or transcription (33½ rpm).

SLOW SPEED—Used on all "transcription", 33½ rpm.

These are only some of the terms used but they are all important. Reference will be made in the following paragraphs that require their use and the reader is urged to master them before attempting to digest the technical content of the series.

Applying Sound to the Cutting Head

Much disappointment can be spared in making records if the recordist has a knowledge of what actually takes place in the cutting head. First of all—let us visualize the action of the needle as it swings from side-to-side

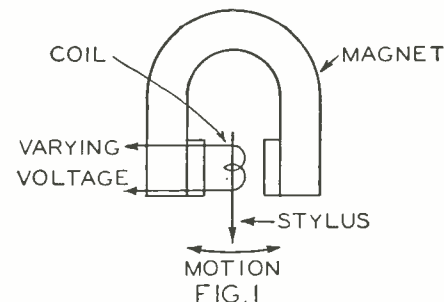

within the record groove. It is similar to an engraving process done by hand, only instead of the hand guiding the cutting tool, a magnet or other source for actuating the cutting needle is used. If a magnet is arranged as shown in Fig. 1, and a coil of wire placed in the position shown, the magnetic field will be disturbed if a varying current is passed through

(Continued on page 43)

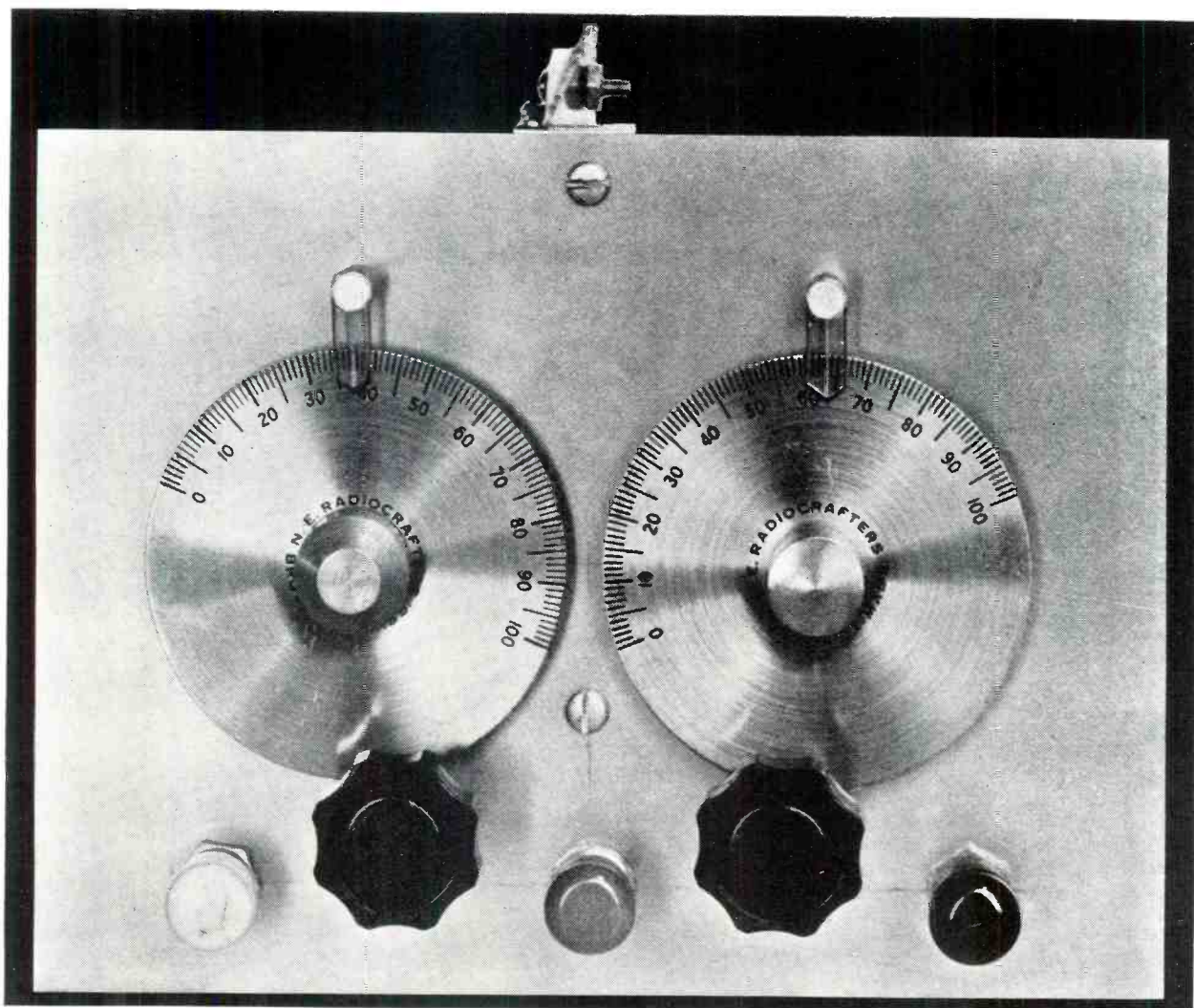

Front view of the receiver shows the two tuning dials and knobs for the three potentiometers.

3-Band U.H.F. SUPER-REGEN.

by **CLARK E. JACKSON**

New York, N. Y.

Excellent reception of the ultra-high frequencies is made possible by use of special acorn tubes in this three-band receiver.

AT various times in the past, super-regenerative receivers have been built which performed fairly well but were lacking in certain refinements. The usual faults encountered were: lack of sensitivity, critical regeneration control, and radiation from the receiver. Probably the worst of these disadvantages, particularly in a large city, is the radiation from the receiver. In times of greatest activity, the interference from these radiating receivers is so great that reception of all but the strongest signals is impossible.

Several methods of overcoming

these disadvantages are possible. While converters provide high sensitivity and selectivity, they offer little relief from man-made interference so prevalent in large cities. In addition, the selectivity is too great for most of the modulated oscillators used on the 112 and 224 megacycle bands.

The receiver to be described overcomes these disadvantages and provides a high sensitivity, freedom from ignition noise, and sufficient selectivity, with a minimum of adjustments. The coils for the 43 megacycle F. M. band were included for occasional listening to F. M. transmissions. An

RCA 954 was chosen as a regenerative R.F. stage to provide increased gain, freedom from radiation, increased selectivity, and ease of adjustment of antenna coupling. This Acorn tube is impedance-coupled to an RCA 955 super regenerative detector.

A 6C5 (RCA) is used as a *separate* quench oscillator to provide a smoother adjustment of quench voltage than that obtained with a self-quenching detector. Audio output sufficient to drive the speaker is furnished by an RCA 6F6 output tube. A connector for a feeder of co-axial cable is provided to enable the use of this cable

Right: Top view shows placement of parts. Note spare coil assemblies.

as a lead-in, especially for mobile work.

The receiver was constructed compactly, and no power supply was included as it was desired to use the receiver in a car, using the power supply from the regular auto radio. No attempt has been made to gang the tuning of the r.f. and detector stage as the great selectivity afforded by the r.f. stage when in a position of greatest sensitivity makes tracking difficult. For ordinary use, it will be sufficient to do the majority of tuning with the detector condenser, using the r.f. condenser to peak the signal.

Construction

The receiver is constructed on a 4½ x6x1½" chassis formed of a sheet of *Erado* metal 7½x9". A front panel of the same material, 5x7", is used. Isolation of the r.f. and detector stages is obtained by means of an *Erado* shield plate measuring 3x4½" mounted in approximately the center of the chassis and bolted to the front panel by means of a half inch lip. The tuning condensers for both the r.f. and detector stages are mounted on small pieces of *Millen Quartz Q.*, which are fastened to the chassis by means of small brass angles. Phone tip jacks are mounted on these pieces near the upper edge to act as sockets for the coils.

The antenna coupling condenser, C1, can be seen mounted on a small stand-off just to the right of the r.f. condenser, while to the rear are mounted the 6C5 quench oscillator tube and quench coil. A hole is drilled through the baffle plate isolating the stages to allow the plate end of the 954 Acron tube to protrude into the detector compartment. This hole should be made large enough so that the tube clears the hole by at least ¼ inch. The socket for the 955 detector tube is mounted on the other side of the baffle below the 954 tube by means of small spacers. It will be necessary to drill a small hole in the baffle to clear the tip of the tube.

The 6F6 output tube is mounted to the rear of the detector tuning condenser. By-pass condensers are mounted as close to the socket terminals as possible and all r.f. ground connections are made to one or two common points. This is *essential* if maximum performance is to be obtained.

Along the rear edge of the chassis may be seen the socket for the power connections, *Amphenol* co-axial connector, and phone jack. Short lengths of bakelite rod, together with ceramic flexible couplings, are used to connect the tuning condensers to the dial. Panel bearings are mounted on the front panel to serve as supports for proper alignment of the dial assemblies. Small 2¾" *Radiocrafter* vernier dials are used to drive the tuning condensers. Parts are placed under the chassis wherever convenient, as can be seen in the under-view of the chassis. They must be "tied down."

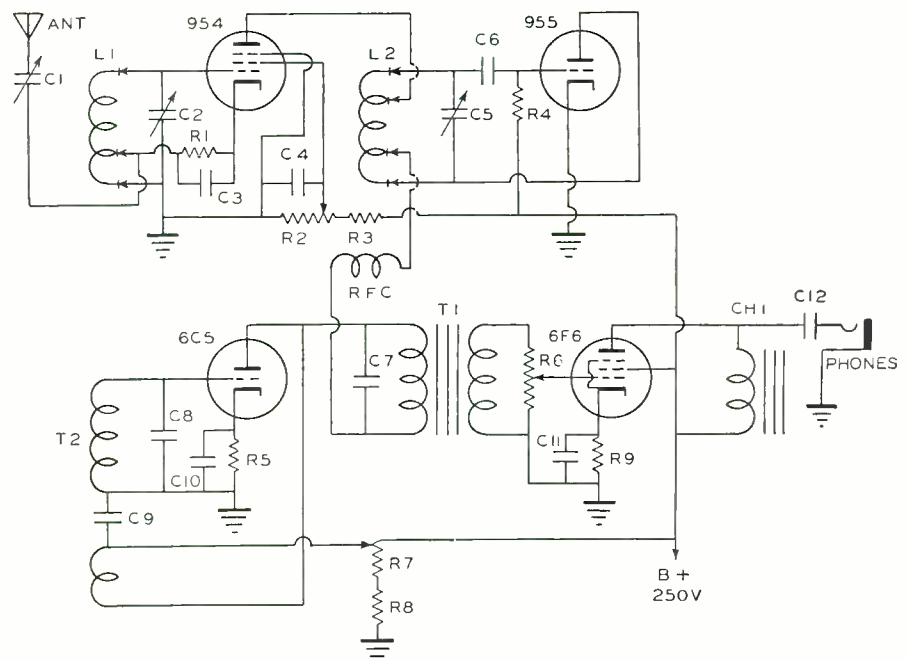
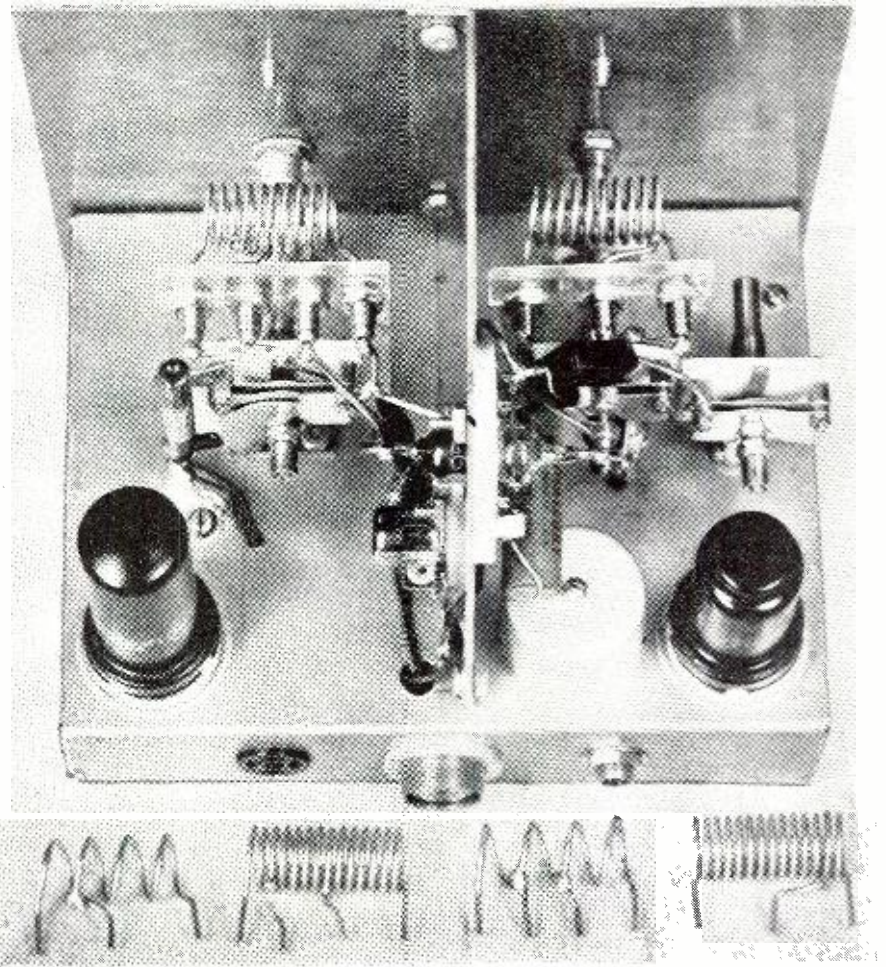

Circuit diagram of the 3-band receiver.

C₁—25 mmf. midget var., Bud
 C₂, C₃—15 mmf. midget var., Bud
 C₄—0.01 midget mica, Mallory
 C₅—0.001 mfd., 400 v. paper, Mallory
 C₆—0.001 mfd. midget mica, Mallory
 C₇—0.002 mfd. midget mica, Mallory
 C₈—0.005 mfd. midget mica, Mallory
 C₉, C₁₀—25 mmf., 400 v. paper, Mallory
 C₁₁—0.1 mfd., 400 v. paper, Mallory
 C₁₂—10 mfd., 50 v. electro., Mallory
 R₁—350 ohm, ½ w., Aerovox
 R₂, R₃—25,000 ohms pot., Yaxley

R₄, R₅—20,000 ohms, 1 w., Aerovox
 R₆—1 meg., ½ w., Aerovox
 R₇—2000 ohms, ½ w., Aerovox
 R₈—500,000 pot., Yaxley
 R₉—400 ohms, 10 w., Mallory
 T₁—3 to 1 interstage Thordarson, T47A25
 T₂—100 KC quench oscillator, National OSR
 Ch₁—40 MA Filter choke, Thordarson 13C26
 Dials, Radiocrafters
 Tubes—RCA 954, 955, 6C5, 6F6
 Acorn Sockets—Millen
 Sockets, Amphenol

Wiring

R.f. wiring should be run as short and direct as possible and kept well-spaced from other components. No. 14 or 16 tinned wire should be used for this purpose. The remaining wiring may be done with ordinary push-back wire, run "point to point." Tie lugs are used wherever convenient and furnish handy mountings for resistors, condensers, etc. Coils should be close wound of No. 14 tinned wire on a form $\frac{3}{8}$ " in diameter, and then removed and spaced to the desired length. Taps should then be soldered in the proper position and the leads adjusted to conform to the tip jack mountings.

Testing

After completing the construction, a power cable should be made up and the unit connected to a source of filament and plate voltage. This should be capable of furnishing 6.3 volts at 1.2 amps, and 250 volts at 40 ma. The greatest activity at the present time is on 112 megacycles, and coils for this band should be plugged in. After the tubes have warmed up and an antenna connected, a pair of fones should be inserted in the phone jack and the potentiometer, R7, advanced until the characteristic super regenerative hiss is heard.

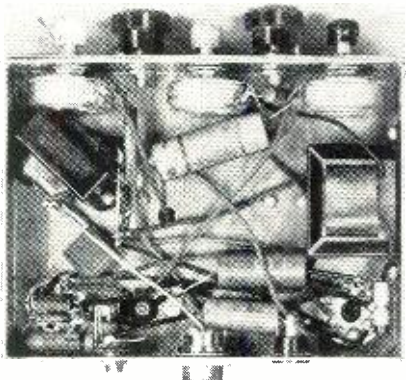

The r.f. regeneration control should be kept *below the point of oscillation* while the antenna condenser should be about $\frac{1}{2}$ meshed. Tuning slowly with C5 and resonating C2 to the point of greatest background noise, it should be possible to hear several stations. After a signal has been located, R2 should be advanced to a point just below oscillation. Failure of this stage to oscillate may be due to too close antenna coupling, or the cathode tap being located too far down on the coil. This stage, however, should never be used in an oscillating condition.

The antenna coupling may be reduced by turning the antenna condenser, C1, toward *Minimum*. Dials on C2 and C5 should track fairly close with the bands occupying about 75% of the dial. It may be necessary to vary the coils slightly by squeezing, or stretching the turns in order to make the two controls track. Some adjustment of the taps on L2 may be needed in order to secure optimum performance, although the specifications given

(Continued on page 49)



by **WILBERT T. PETERSON**
Illinois State Police Dept.

CLOSER co-ordination with the National Defense situation seems to be the aim of many of our police departments here lately, as much of our police work has been diverted to furnishing escorts for army caravans, setting up radio contacts with the various ordinance departments, etc. We are under the belief that the government is realizing more every day the great value of our police radio communications systems to our national defense program.

We see that Lee Stull, chief engineer of the *East Chicago, Indiana* radio system has offered his station's services to the coast guard. Lee is making arrangements to place a 2-way mobile unit of the same type used in his cars aboard the local coast guard cutter which will allow 2-way communication between the cutter and the station whenever it happens to be in the vicinity of *East Chicago*. He is also planning on setting up a receiver of the coast guard frequency in the police station so that, if necessary, he can relay traffic for the coast guard via the police networks.

This, in our opinion, is a wonderful example of what can be done in working toward a closer co-ordination between the government and the various police departments. It shows us that just an ordinary police radio station on the shores of Lake Michigan can be a tremendous asset in case an emergency arises. To cite an example, this coast guard cutter could send a message to *East Chicago*, who in turn would send it to the Dunes Park station of the *Indiana State Police*, who in turn would relay it by radio-telegraph to the interzone station at *Indianapolis*, who in turn could send the message either direct or by other relays to any police radio station in the *United States* having an outlet to one of the stations of the National police radio-telegraph network. In this manner it would be possible, for instance, to get a message from the cutter to any police department in the state of California in a matter of minutes!

Stull uses *Doolittle* equipment exclusively, having a total of eleven 2-way cars. He has 5 remote receivers brought in on one telephone line. The department has two districts, the station being located in district one, with the transmitter remotored from the second district at the other end of town.

The *Gary, Indiana* police department have recently switched over from AM to FM, and according to the radio engineer Floyd Timberlake, the system is working out very nicely. Floyd has taken charge of the radio system since April 1st this year, and at this time has twenty-one cars equipped with 2-way FM units, and has installed the station house transmitter and receiver using *GE* equipment. He claims that many dead spots had been experienced throughout the city using AM rigs, but that this condition is eliminated entirely under the new FM setup.

Timberlake is also in the process of designing a communication alarm system for the *Gary* fire department. There are eight fire stations in the city, and each will be

equipped with a PA system controlled from the central fire alarm station. Each fire station can be called individually, or they all can be called at one time. Direct telephone lines will be set up from the central fire alarm station to the various districts for this purpose.

Michigan City, Indiana features a complete *Motorola* installation of 50 watts on 31,500 kc. four squad cars and the fire chief's car are equipped for 2 way communication. Victor Cristman services the city.

Berrien County, WSTJ, is a very neat installation with a power of 500 watts located in *St. Joseph, Michigan*. This station also services the twin cities of *Benton Harbor* and *St. Joseph*. Each city has three cars equipped with *Bassett* 2 way mobile units, and the county has eleven cars using the same equipment.

The chief op is R. B. Swigert, who also maintains a radio service shop in town. The two cities and the county all operate the one transmitter from their respective offices.

Laurel Keen, chief radio man of the *Michigan State Police* station at *Paw Paw*, is keeping very busy these days building a push-button controlled CW rig, and a co-ax antenna to be placed on top of the station's vertical antenna.

The CW rig, when completed, will be used to operate on the zone frequencies with the state control station at *East Lansing*, and to communicate with other zone stations nearby.

The co-ax antenna will be set up to run some experiments with 2-way FM communication between a mobile unit and the station. Tentative plans will be made soon to have 2 way FM communication between the numerous posts located in the state with the 3 state stations now in operation.



Maywood, Ill., FM radio.

The present state radio set-up in *Michigan* includes three stations, *East Lansing*, *Paw Paw*, and *Houghton Lake*. *East Lansing*, WRDS, is the interzone station for the net. At present the only two zone stations in the state are the municipal stations WPEB, the city of *Grand Rapids*, and WQMG, the city of *Pontiac*.

The state also has a Department of Con-

(Continued on page 54)

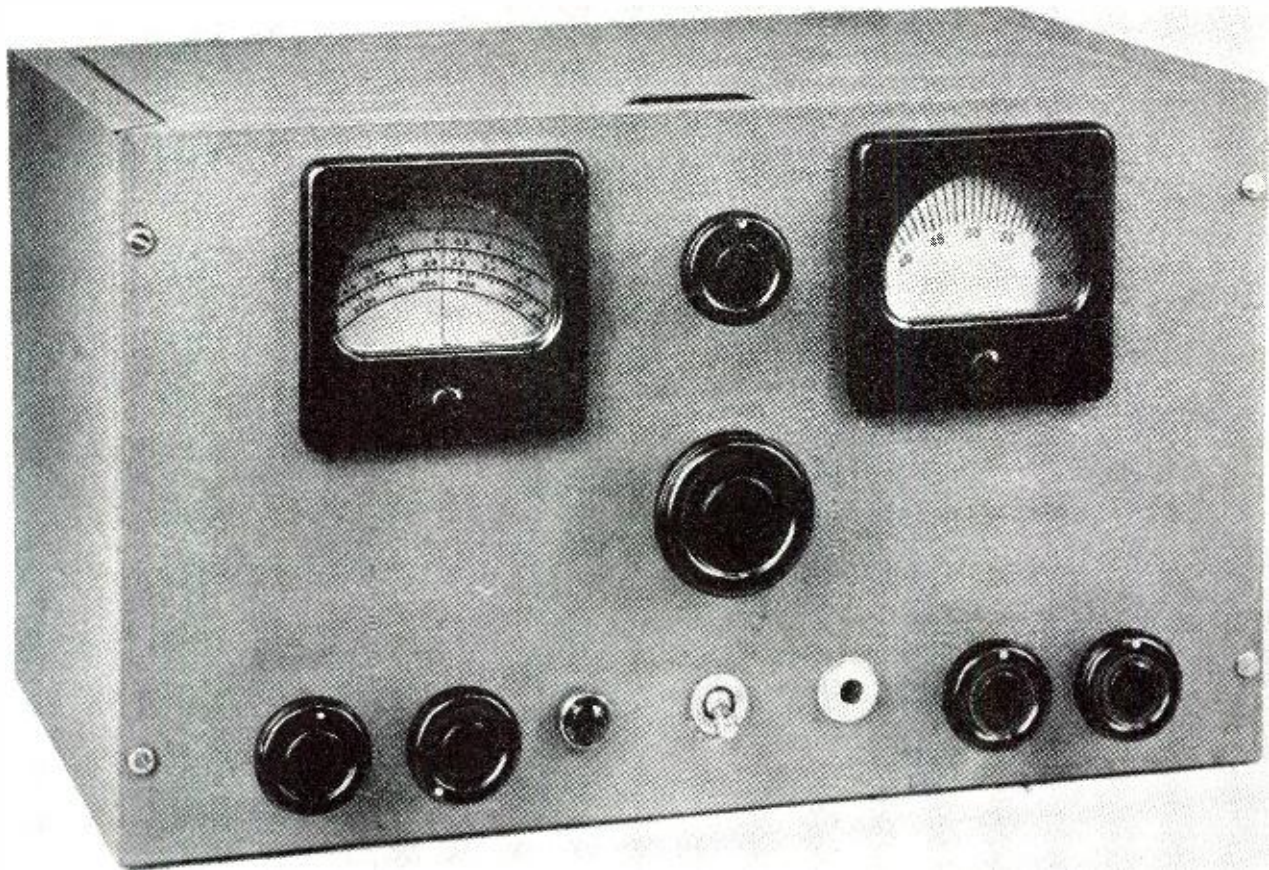

The completed receiver is housed in a standard cabinet. Band-set dial is at left; band-spread at right.

Portable All-Wave Receiver

by **RAYMOND B. FRANK, W9JU, RADIO NEWS**

Amateur radio facilities are vital to national defense efforts. This portable emergency communications set will serve admirably.

THOSE of us who participated in the *National ARRL Field Days* during June will by now know just how well (or how badly) they can build units to take 48 hours, more or less, of continual operation under far from ideal conditions. You will have seen how resistors get too hot, electrolytics blow when their ratings are exceeded, and how the whole function of a field station can be interrupted, if not destroyed for the want of a receiver, a resistor, a condenser, or most often because of "cranky" units.

There are two ways to attack such a situation. The first, and the worst, is to throw up your hands and say, "Aw, the devil with it!" The other is to sit down with the gang that were with you, or by yourself, and dope out what went wrong and why. Then get to rebuilding along lines indicated by the results of your investigation.

Personally we had been using make-shift portable receivers for more years

than we care to admit. And sometimes they pulled in the dx like the finest fixed station super in the world, but more often they just went sour, and like a moody horse, were left at the post.

With *National Defense* stressing that each ham should have portable gear that works, it was folly to continue to think that the make-shifts would ever become so good (and reliable) that we could ever really depend on them. We decided to make the obvious change and design a receiver from scratch which would and could be "nailed down" and deliver the goods, come hell, come high water.

When we got through with the assorted diagrams, and lifted our heavy head from the welter of magazines, catalogs and text-books, we were astounded to discover two things. One, the receiver from scratch would cost much much more than we could afford to lay out, and secondly there was a

strange resemblance to a *SkyBuddy* in the final diagram we had decided on. Why not do the obvious—get ourselves a 2nd hand *SkyBuddy*? Since there are about 25,500 (actually there are more than that) of these units in the hands of the consumers, we had little difficulty in finding one in very damaged condition which became ours for exactly \$3 not including tubes. This "junk" receiver, old, dusty and damaged would be the basis for our new portable unit. It was hard to think that the transformation could be made, but it was. We were on the path to a battery-operated portable receiver.

Then the thought occurred, why not make it a "three-way" so that it could also be used from a.c.-d.c. power lines as well as with its self-contained batteries. While this conversion in particular applies to the *SkyBuddy*, similar conversions can be made with receivers of its general type, or regularly commercially available coils may be

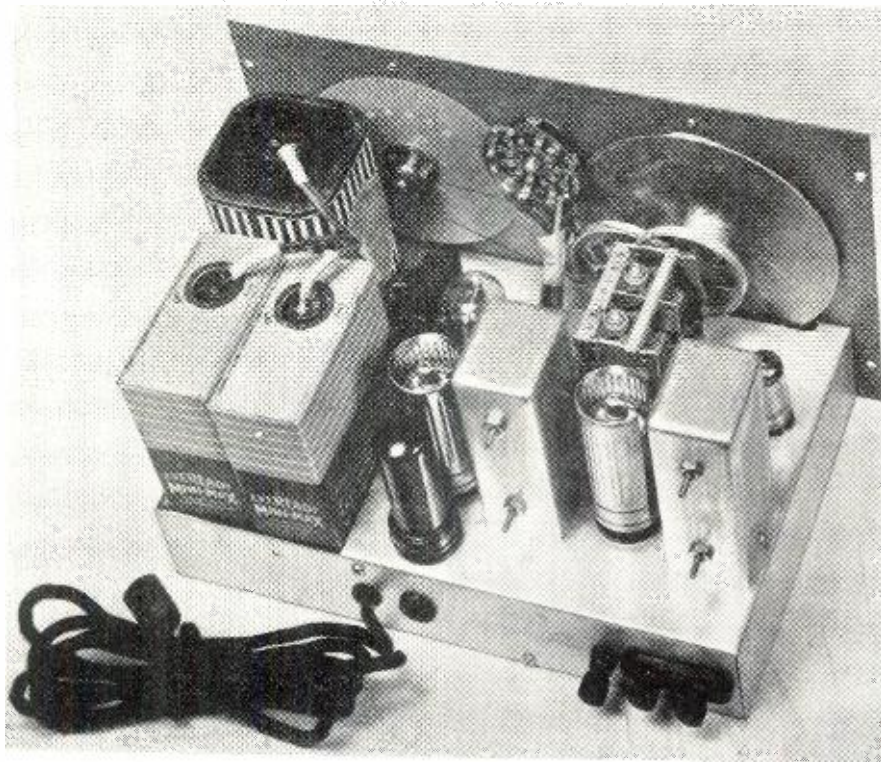

Careful planning permits a neat arrangement of parts plus battery space.

purchased. The physical size of this receiver was dictated by a companion transmitter already built and the desire to keep the receiver as small as possible. An external speaker is used

because of microphonics common to some battery operated tubes.

Circuit

The original mixer tube in the Sky-Buddy was a 6K8. In search for a

suitable 1.4-volt substitute a 1A7G was tried. Even with a 1A5G as a separate oscillator, oscillation was not continuous over all bands and the stability was not good. It would not be wise to alter the coils to use a 1A7G tube, so a 1R5 was tried as a combination detector oscillator, and found satisfactory.

Due to the "A" battery being limited to 6 volts, it was necessary to limit the set to 4 tubes, plus the rectifier. The final layout was a 1R5 detector-oscillator, a 1N5GT i.f., 1N5GT regenerative grid leak second detector and a 1A5GT output. The 25Z6 was used as a rectifier for operation from 115 volt line. The addition of regeneration to the second detector permits its use in an oscillating condition for the reception of c.w. signals, and just below the oscillating point for reception of modulated signals. The poor selectivity usually afforded by a grid-leak detector is more than compensated for the regenerative feature and the "single signal" effect is quite pronounced on c.w. signals. No r.f. gain control has been provided for as it was not found necessary. The 25Z6 was selected for use as a rectifier rather than one of the 117 volt types, and used in conjunction with a line cord as it was desirable to keep as much heat out of the cabinet as possible in order to improve the stability. Separate filter systems are used for the plate and filament circuits to reduce hum.

When used on a 115 volt line, the stand-by switch controls the filaments and "B" supply only, while allowing the heater of the rectifier to remain on. On battery, both the filaments and

(Continued on page 44)

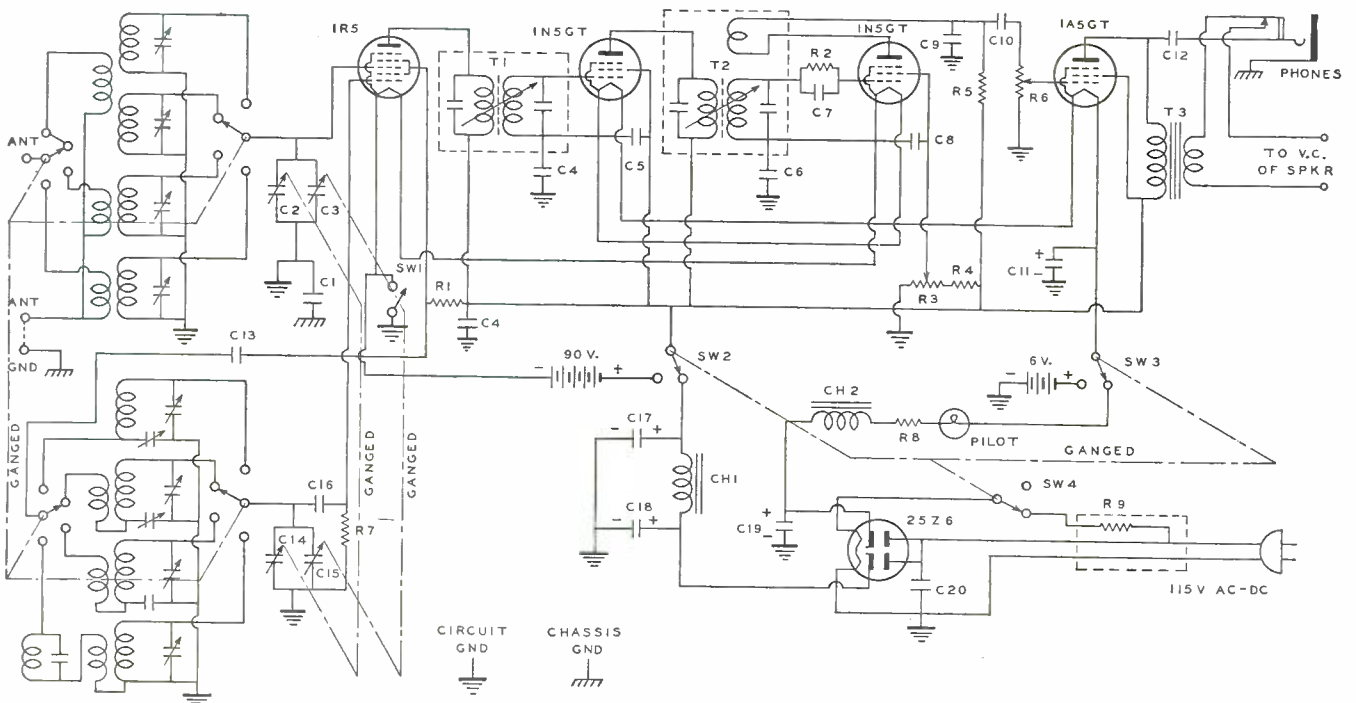

- C₁, C₄, C₅, C₆, C₁₀, C₂₀—.05 mfd., 200 v. paper Mallory
- C₂, C₃, C₁₁, C₁₅—2 gang tuning condenser with bandspread section (Sky Buddy)
- C₇—.00025 mfd. postage stamp mica Mallory
- C₈—.1 mfd., 200 v. paper, Mallory
- C₉—.0001 mfd. postage stamp mica, Mallory
- C₁₀—.02 mfd., 400 v. paper, Mallory
- C₁₁—100 mfd. 25 v. electro, Mallory
- C₁₂—.002 mfd. postage stamp mica, Mallory
- C₁₃—.00005 mfd., postage stamp mica, Mallory
- C₁₄, C₁₆, C₁₇—40 mfd., 150 v. electro, Mallory
- R₁—20,000 ohms, 1/2 w. IRC

- R₂—2 meg., 1/2 w. IRC
- R₃—50,000 ohms pot. Mallory
- R₄—25,000 ohms, 1/2 w. IRC
- R₅—150,000 ohms, 1/2 w. IRC
- R₆—500,000 ohms pot. Mallory
- R₇—100,000 ohms, 1/2 w. IRC
- R₈—1500 ohms, 10 w. Ohmite
- R₉—310 ohm line cord Ohmite
- T₁—455 Kc. permeability tuned IF (input) Millen 64454
- T₂—455 Kc. permeability tuned IF (See text) Millen 64454
- T₃—Universal spkr to voice coil, Stancor A3856
- SW₁—SPST toggle

- SW₂, SW₃, SW₄—3-pole double throw, Mallory
- SW₅—4 section—4 position (coil shorting) band switch, Mallory
- Ch₁—50 hy @ 15 MA filter choke, Stancor C1515
- Ch₂—30 hy @ 50 MA filter choke, Stancor C1003
- Pilot light—60 MA, 2.0 v. 148
- All RF coils and padding condensers not marked are taken from Sky Buddy
- Cabinet and Chassis—Bud
- Batteries—2 2482 Minimax, 1 24PIX Burgess



SERVICEMAN'S EXPERIENCES

by LEE SHELDON

THE usual daily routine of *Salutary Sales & Service* begins when my partner and I meet at the corner restaurant. Then we sit in the rear of the shop and read our papers while we settle our breakfasts and digest the news of the world. Lately the news has become so complicated we often find we have digested our breakfasts before any of the world's affairs have been settled.

Al must have thought these periods a waste of time, because, on this particular morning, he let me read alone and busied himself at the workbench. He put pieces of scrap aluminum in one box, copper in another. Naturally, I was a bit piqued to think our early-morning tradition had been broken, even in the interest of national defense, so I turned and remarked:

"Here's a funny item, Al. Man in Honky Snack, Alabama, wrote a note to the city fathers when they called for aluminum, saying: 'I am sending you my wife, who is an old pot. Let me know if you are able to melt her down.' Pretty good, eh?"

My partner hove a sigh and replied: "There's nothing funny about the defense effort. It's a serious business, and may turn out to be even more serious than our own—if it isn't already!"

"No harm in laughing," I came back. "In fact, it's part of the American way. The more serious the task, the more we will need laughs. Don't tell me I'm unpatriotic!"

"You probably don't mean to be," Al replied, "but the fact remains I have spent the last fifteen minutes collecting junk parts to help the country, while all you've done is joke about it."

"That's not fair," I said. "I'd gladly have sorted those parts—as soon as they were called for. What *can* a serviceman do to help in the defense effort?"

"Same as anyone else who stays at home," Al replied. "He can buy Defense Bonds, or contribute to the U.S.-O., or the Red Cross. Many servicemen are amateur operators who are qualified to volunteer for work in the regional groups that hold practice sessions on the air to provide alternate communication routes in the event of natural or man-made disaster.

"If you want to make a fine point in the profession, you might say that every repairman renders a public service every time he fixes a radio, for each properly-working receiver adds to national cohesion. Then, too, he can use his experience in effecting proper repairs with the utmost econ-

omy of the metals required by the rearmament program. Things like these may be small items in each store, but multiply them by the number of servicemen, and it will represent appreciable assistance."

"Al," I said, "I know all these things, and I'm willing to do whatever I can. But be more specific—if I decide today, for instance, to do something special to help the nation, what could it possibly be?"

"You ask at the right time," Al told me. "Today you are to go to Washington Hall to make arrangements for the rental of a public address system at a patriotic rally being held tonight. Let them use our best amplifier; have plenty of spares at hand, and watch the rig closely during the meeting. Thousands will attend, and it is very important the equipment works properly when appeals are made."

That was more like it! Here was an assignment, just like one in the Army or Navy, where you were told to do something you knew was useful. I wired a little flag to the radiator cap, and hummed "Anchors Aweigh" as I drove to Washington Hall.

A Miss Crocker explained what was needed: a microphone for the stage, and a pickup for a song which had been recorded for them the day before. Two loudspeakers, one at each side of the stage, would cover the crowd. Duck soup!

"Miss Crocker," I said, "I am sure glad to take part in this rally. In fact, I am so glad that I will give you my time and equipment without charge!"

"Sorry," she replied, "but the Arrangement Committee has ruled against such offers. We had a very

unfortunate experience last month when a serviceman who did not charge rental supplied us with inferior apparatus and nearly ruined our program."

"The dastard!" I said.

"We will pay your regular charge," she continued. "The way you can help us most is to be sure your equipment is entirely dependable."

"It *shall be*," I promised. "Furthermore, I plan, after we receive your check, to endorse it and return it immediately to your fund."

"What you do with your money," Miss Crocker said, rather impatiently, "is your own concern. What we want most from you just now is reliable apparatus!"

I loaded our best amplifier, speakers, and turntable into the truck. Al watched me.

"Going to take spares?" he asked.

"Never needed them before," I replied, "but on this job, guess I'd better," and loaded a duplicate set of tubes, another turntable, another mike, and some fuses into the truck.

That night, after I had installed and tested the equipment, I sat proudly in the audience. The weather had been perfect, and the hall was filled to the rafters. The recording was to be played as the final number, and I planned to dash back-stage to the amplifier about ten minutes before the switch.

As the program got going, the audience became more enthusiastic than fruit-flies over a cantaloup. The singing, the flags, the people who thought as one in the cause of freedom, all made me tingle with pride. And it was *Salutary Sales & Service* equipment that was getting the message across!

The final speaker was a popular senator who had flown all the way from Washington to attend. Within ten minutes he had brought us all to our feet, cheering and applauding. Taking advantage of the excitement, I ran up the side stairs and stood in back of the curtain until the noise subsided. The senator resumed—and the loudspeakers went dead!

I noticed Miss Crocker glance angrily back to the room where I had laid the amplifier. Then she saw me behind the curtain. Hastily, she pointed to the mike, waving me onstage.

Panic-stricken, walking out in front of a hushed audience that must have included hundreds of our customers, I stepped in front of the senator and shakingly tipped the mike stand to-

(Continued on page 58)



"... and this is our latest double-feature television set."

Main entrance to Scott Field, Illinois. United States training center for Air Corps radiomen.



U. S. ARMY Air Communications

by **CAPT. J. R. JOHNSTON, Scott Field, Ill.**

Students receive complete training in airadio communications under expert Gov't supervision.

THE ham radio operator has come into his own at last. Literally hundreds of youths who once filled the air with their plaintive "CQ, CQ," are being taught to be the "ears and voice" of the army air corps in the Radio Communications Center at *Scott Field, Ill.* By Nov. 3, more than 15,200 young men will have been graduated, and 10,000 more will be entering upon a course covering 22 weeks, but packed with "learning" that usually takes a year to acquire.

To fill this schedule, 400 students from air corps posts all over the nation enroll every two weeks while an equal number graduate. Before winter sets in, however, twice as many will enroll and graduate over the same interval. To this end, School Unit No. 1, with its more than 120 buildings,

Student operates shielded loop antenna. It resembles a miniature blimp.



Private Jack Walworth receives instruction on copying code. Advanced students are taught to use a typewriter and "bug."

Milwaukee Journal Photo





Instructors give individual pointers to students. Note modernistic desk.



Each student gets an opportunity to contact ground stations from the "flying classroom," a huge Army bomber holding 12 students and crew.

will be duplicated to form School Unit No. 2 of the Air Corps Training School for enlisted men. *Scott Field* will then be graduating 20,000 men a year.

All this is necessary to provide the 30,000 pilots now being trained for the nation's defense with the necessary 100,000 technicians. Radio operators and mechanics are bound to play a most important role.

"Radio," says Col. Wolcott P. Hayes, Post Commander, "has become as important a combat device as the planes themselves. All the tactics of today are built around it. Modern warfare's combat teams on the ground, in the air, and on the seas are coordinated to operate together with striking swiftness through radio. Modern warfare is impossible without radio."

Recruited from among radio "hams"

and others interested in radio work, the school's enrollees average much younger in age than any other similar element in the army—the mean average being less than 21 years. And with at least a high school education, or its equivalent, they also form the most intelligent and sharpest-witted group. The intensive course given them is attuned to their intelligence. In a short period they must absorb a vast store of knowledge about radio and at the same time acquire an almost automatic skill in reading and sending messages in code.

This is done through a system of gradual but sharply delineated progress by classes synchronized for the purpose of gaining speed in the course, and yet affording sufficient elasticity for individual students to cover par-

ticular phases of the work at a more leisurely pace, or repeating them if necessary.

For this reason, the course is broken up into 18 phases in which are taught radio shop mathematics, electrical fundamentals—direct and alternating current theory, transmitters—including antennae and vacuum tubes, receivers, circuit analysis, use of manual tools, operation of command sets, use of radio compass, and medium and high-power liaison sets, maintenance and inspection of radio equipment, the basic code with a minimum of eight words per minute required, radio telephone and telegraph procedure, and flight operation and practice in tactical radio nets with code checks of from 16 to above 25 words per minute.

Upon graduation from the course,

Visitors at Scott Field, home of the Air Corps radio school, watch a transmitter demonstration.

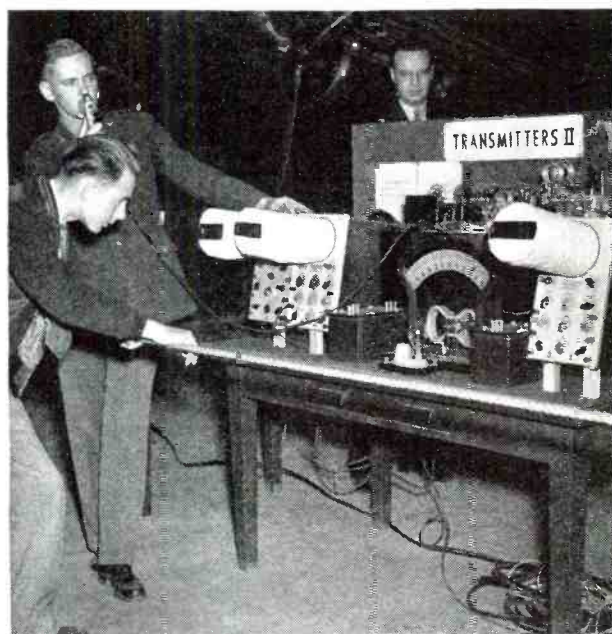

Theory and operation of radio beams are taught to the class by competent instructors. Students also get practical experience.

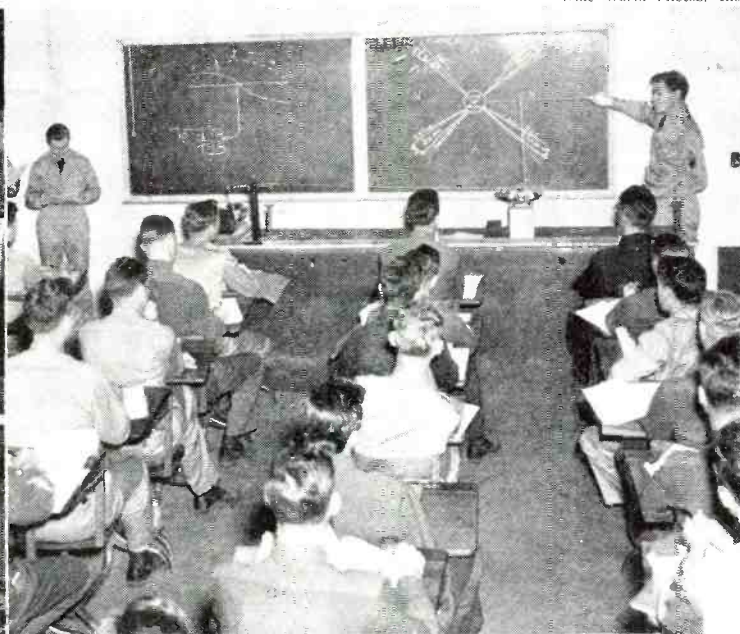



Milwaukee Journal Photo

Flying cadets learn to be communications officers. A directional loop antenna is examined by two students.

the students are assigned to work as aircraft radio operators, aircraft line maintenance radio mechanics, or ground radio operators or mechanics.

A course is also contemplated for training communications personnel for the *Army Airways Communications System* which closely parallels the *Civic Aeronautic Administration*.

There is also a school for aviation cadets who take a similar course covering 16 weeks of intensive study. Upon graduation, aviation cadets are commissioned as second lieutenants in the reserve and are used as squadron communications officers. At present, new classes in this course begin every two months. Candidates are obtained from among college men and the standards of physical fitness are as high as those of flying cadets.

Still another school operates at *Scott Field*. This is the Air Corps institute which provides courses of study for 10,500 correspondence students at stations as far away as Panama, Alaska, Chile and Hawaii. This system is used principally by those who have applied for enrollment to the technical school but who have not yet been entered, and for radio operators and mechanics who wish to keep abreast of the latest advances in radio communication. So popular is this school that there is at present a waiting list of 1,900.

In all there are 4,400 students in the Technical school and a permanent party of 1,200 men who constitute the overhead to take care of the school unit. With the expected increase in enrollment this fall there will be 11,200

men in the school alone, not counting the aviation cadets, who will remain a separate and independent unit.

To maintain this large school population, a veritable city had to be built

Installation of radio equipment is studied on these heavy Army planes.



Here is one of the code rooms. The finest equipment is used by the Army in its military training centers.



Aerial view of Scott Field shows the vast amount of space required for the present radio training project.



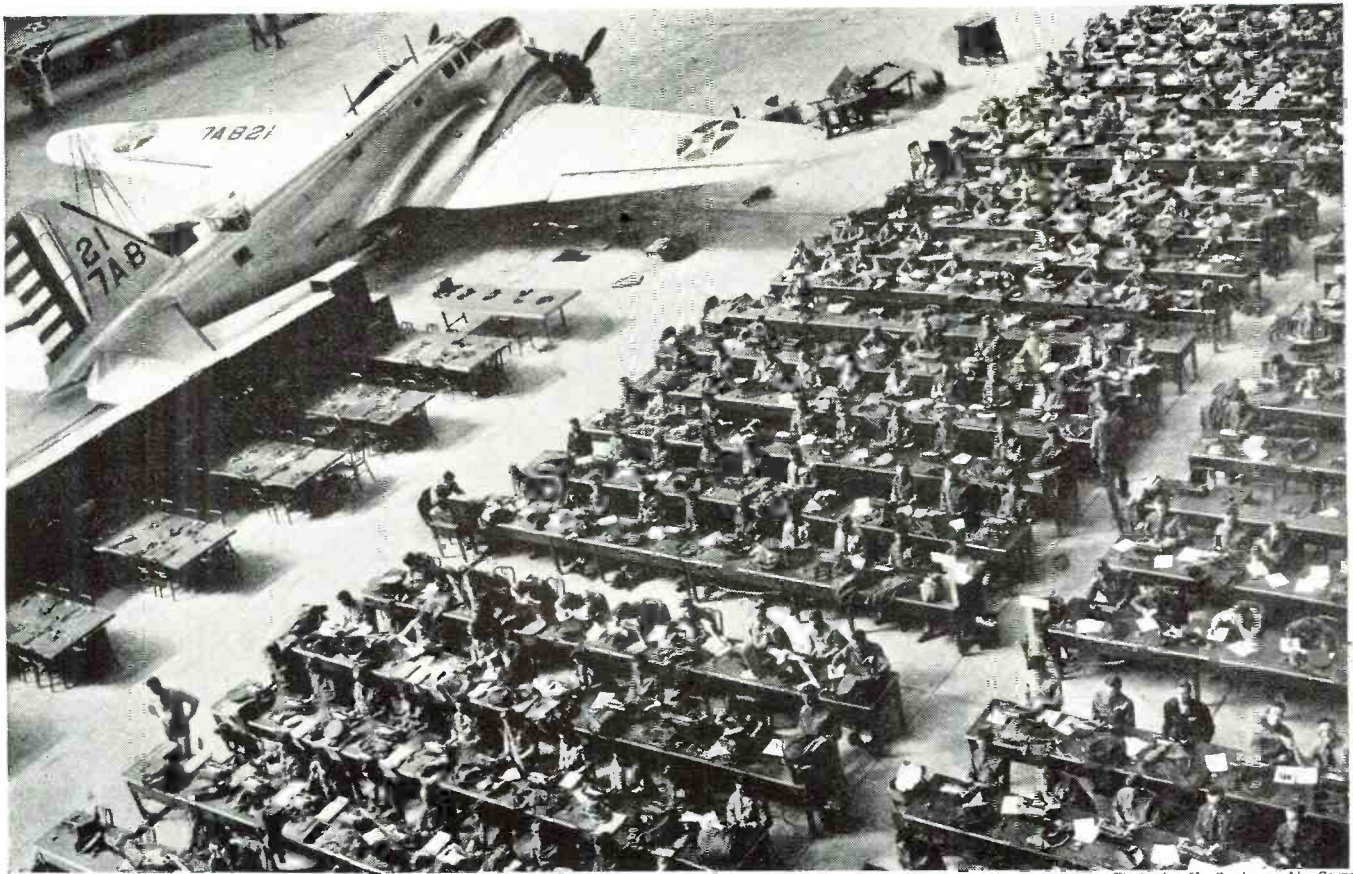

Photo by U. S. Army Air Corps

Here are some of the 6,000 students learning code in hangar "classroom," formerly used for large planes.

at a cost of millions of dollars. In School Unit No. 1 there is a large school building erected last February with 42,000 square feet of floor space. There is a large mess hall with a ca-

Instructor teaching fundamentals of radio antenna feeder lines.



Students at Scott Field attend a class in tactical procedure. This adds to their knowledge of radio technique.



capacity for feeding 6,200 men at one meal—the second largest in the army. Beside this there are innumerable two-story, 63-man barracks, and many other service buildings, all comparatively new and of frame construction.

The present school unit will be duplicated in every way to form School Unit No. 2, which will house sufficient students to double the present enrollment. The school building now occupied will then be converted to the use of aviation cadets.

Serving the entire field is the Seventh Air Base Group which is housed in the more permanent section of the field. In this section are the brick homes of the commissioned and non-commissioned officers and their families; the large headquarters building, which was erected several years ago

when it was contemplated assigning *Scott Field* as headquarters for the entire *Air Corps*; a large hospital, a theater, officers' and enlisted men's clubs, gymnasium, fire station and post exchange. Augmenting the permanent group are more than 1,000 selectees from Illinois, Michigan and Wisconsin who are undergoing training in preparation for assignment to squadrons or to detachments of the quartermaster and medical corps as administration or maintenance assistants. *Scott field is representative of the vast schools that are instructing students in some phase of radio technique. We are indebted to Capt. Johnston for his interesting coverage of the activities at this institution.—Editor.*

—30—

A radio operating class in full swing. Note the patch board in lower right-hand corner used to select circuits.

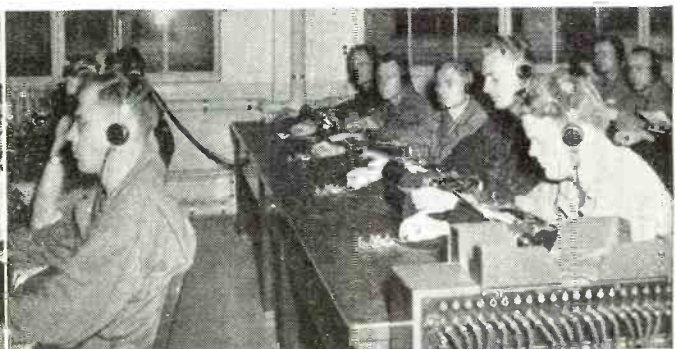

BUILD THIS CHANNEL

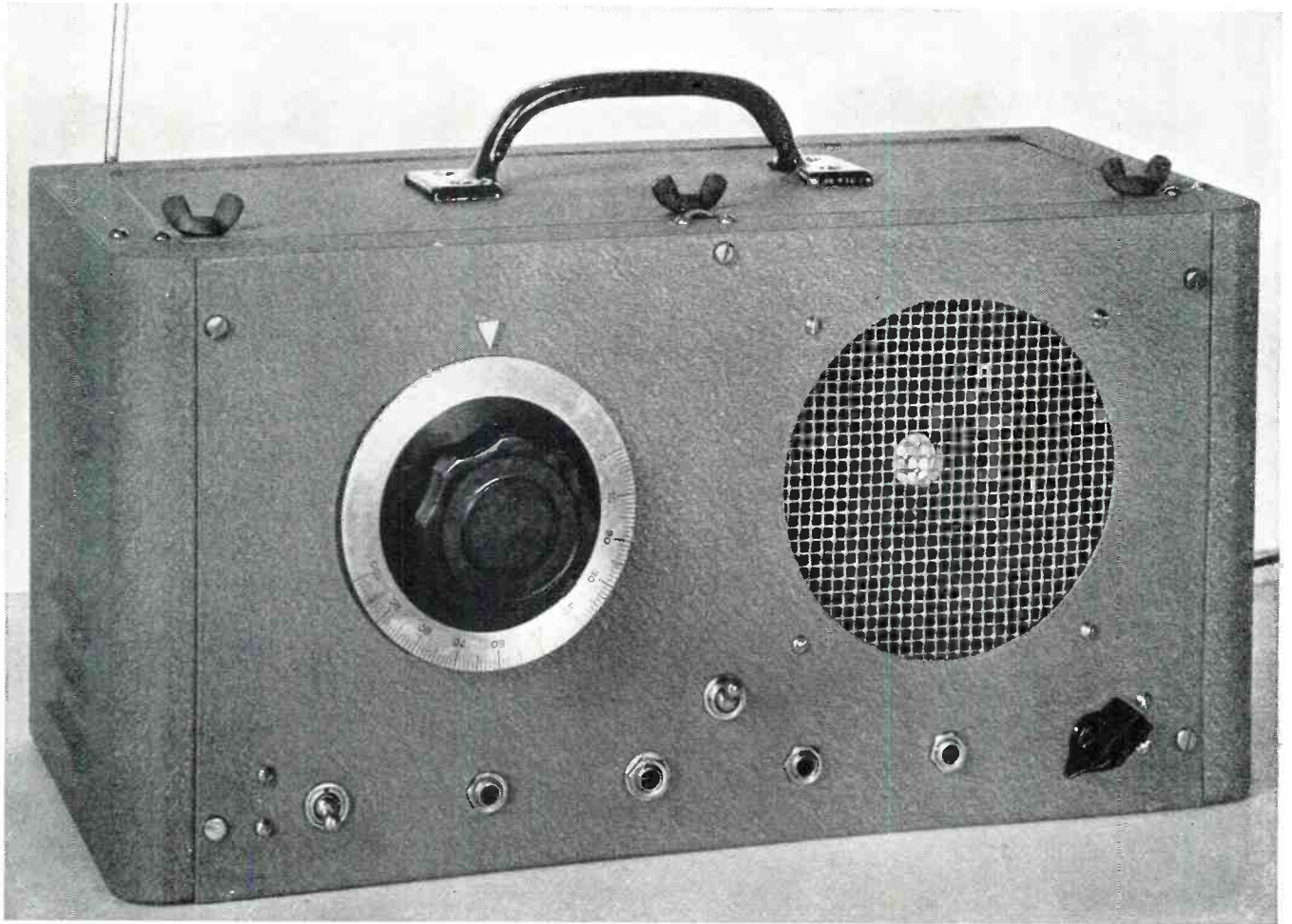

The finished Channel Substitute takes on the appearance of a commercially-built test instrument.

Many service measurements are possible with this latest Channel Substitute. It closely resembles a standard superheterodyne receiver with added circuit features.

THE location and isolation of radio receiver defects is made a comparatively simple task with the use of this instrument. The unit consists of an ordinary super-heterodyne receiver with the r.f., i.f., and a.f. circuits brought out to jacks on the panel. By the mere substitution of these channels with the defective circuit of the receiver under test, trouble can be located very easily.

The channel substitute has an r.f. and converter stage tuned by a two-gang condenser, with an oscillator tuned by a separate condenser brought out to the front panel. The two-gang variable is adjusted to resonate with one of the local broadcast stations—for example, somewhere around 800 kilocycles.

The oscillator tank is then designed to resonate between 995 and 1285 kc.

approximately. Therefore, by adjusting the oscillator control on the panel, any i.f. beat frequency between 175 and 465 kc. will be obtained. This i.f. frequency may be calibrated and marked on the panel providing the same local broadcast station is always used when making tests. In the plate circuit of the converter tube we may then produce any i.f. between 175 and 465 kc., and also the signal voltage of the broadcast station itself. By placing a switch and jack in the plate circuit of this tube, all of these frequencies will be available at our test leads. This jack is called the r.f.-i.f. jack.

With the r.f.-i.f. jack J1, in the normal position, that is, allowing the signal to continue on to the first i.f. transformer, and the oscillator control set to produce an i.f. of 262 ks., which is

the i.f. used in the channel substitute, we then amplify the signal further. By use of another jack, J2, the 262 kc. output of the second i.f. transformer may then be made available at the front panel. This voltage may readily be used for testing diode detector circuits of receivers.

Continuing, the diode rectifier of the channel substitute will then rectify the signal and feed it to the audio amplifier. At this point another jack, J3, is inserted parallel to the diode load volume control. This jack is called the audio input jack, and the audio section of the channel substitute may be used as an ordinary audio amplifier. In this case the r.f.-i.f. switch will be placed in the jack position to cut off the signal voltage which would otherwise be present across the diode load.

The fourth jack, J4, is called the

SUBSTITUTE

by **PETER T. WILLIAMSON**

Chicago, Ill.

audio output jack and is placed in the plate circuit of the 6F6 output tube. The audio frequency is then available at the jack or it may be reproduced on the speaker. It may be cut off from the speaker by opening the voice coil switch on the panel. This will avoid interference between the channel substitute speaker and the one in the set under test.

Construction

Construction work on the channel substitute is very similar to that of an ordinary superhet receiver, however no AVC system is employed. The entire unit is built on a 7" x 13" chassis, and placed in a Par-metal 8" x 8" x 16" deluxe cabinet.

The chassis is not mounted flush to the front panel, but is separated by 1/2-inch spacers. This will allow ample room for the bottom of a 6-inch speaker to clear. The side of the chassis facing the front panel is cut to within a half-inch around each side. This will allow enough room to mount the spacers, and the jacks and volume control can be mounted directly on the front panel without the chassis interfering.

The first procedure is to drill and punch the chassis, then cut the speaker hole in the front panel with an adjustable hole cutter set to a diameter of 4 7/8 inches. The jacks, switches and volume control holes are next in line. The panel is then mounted to the chassis and the various components placed in proper positions.

Care should be taken, when wiring, to keep the a.c. filament leads separated as much as possible from the r.f. and a.f. leads going to the various jacks. The diode input jack should be insulated from the panel. This jack is a closed-circuit type, and is so wired that normally the i.f. coil connects to the 6Q7 diodes through the jack, but as soon as a plug is inserted, the di-

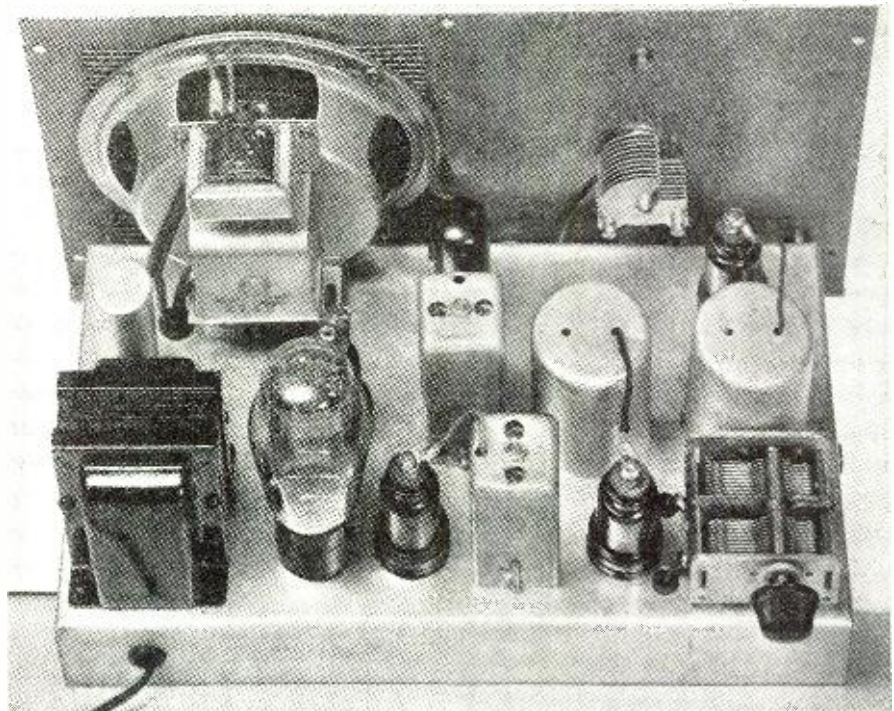

Standard parts are used for construction of the Channel Substitute. The antenna and r.f. condenser is shown mounted at the rear corner.

odes are disconnected and the output of the i.f. transformer is placed on the test leads.

After wiring is completed, the next job will be to calibrate the oscillator condenser on the front panel in terms of intermediate frequencies. The purpose of this oscillator condenser and coil is to resonate at frequencies of from approximately 175 kc. to 465 kc. above the frequency of the broadcast station which we are going to use as our test station. This BC station, of course, should be the one that has the greatest signal strength and is on

the most hours during the day.

After we have determined what BC station we will use, the next step is to set the r.f. and detector gang condenser to a position which we believe will resonate with the station. By then varying our oscillator condenser, we should locate the station, then tune for maximum signal with the r.f. and detector gang. Since the i.f. of the channel substitute is 262 kc., our next object is to get the oscillator condenser approximately half open when resonating with the local BC station.

(Continued on page 48)

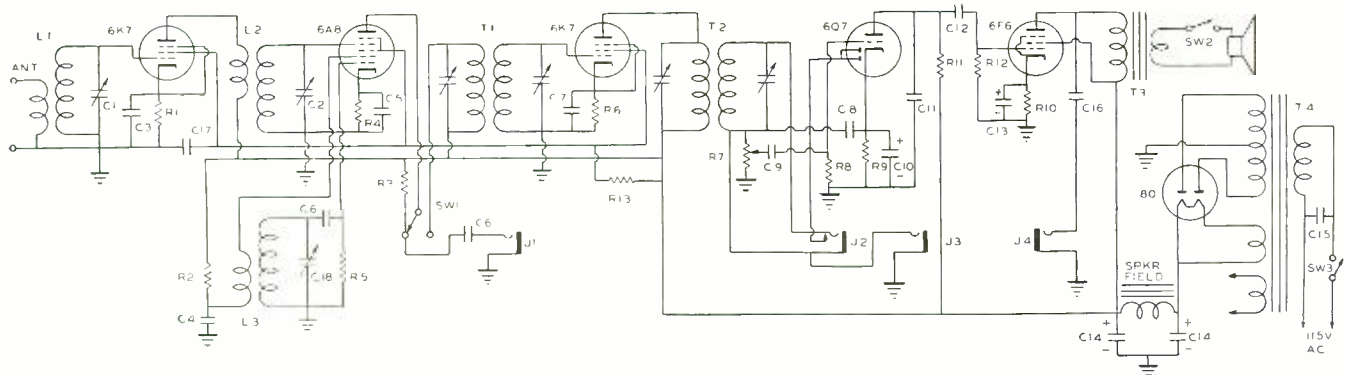

R₁, R₁₁, R₁₂, R₁₃—400 ohms, 1/4 w.
 R₂, R₃—100,000 ohms, 1/4 w.
 R₄, R₅, R₆—1 meg., 1/4 w.
 R₇, R₈—200,000 ohms, 1/4 w.
 R₉—500,000, Centralab vol. control with sw.
 R₁₀—400 ohm 3 w.
 R₁₁—50,000 ohm 1/4 w.
 C₁, C₂—365 mmf., two-gang cond.
 C₃, C₄—0.003 mfd., Aerovox
 C₅, C₆, C₇, C₈, C₉, C₁₀, C₁₁, C₁₂, C₁₃, C₁₄, C₁₅, C₁₆, C₁₇—0.01 mfd., Aerovox

C₁₈, C₁₉—0.005 mfd., Aerovox
 C₂₀, C₂₁—8 mfd., 25 v., Aerovox
 C₂₂—0.005 mfd., Aerovox
 C₂₃—double 16 mfd., 450 v., Mallory FP
 C₂₄—0.0014 mfd., var. Hammarlund
 L₁—Broadcast antenna coil, Meissner 14-1024
 L₂—Broadcast detector coil, Meissner 14-1025
 L₃—175 kc. oscillator coil, Meissner 14-4242
 T₁—262 kc. input IF trans. Miller 512-H-1
 T₂—262 kc. output IF trans. Miller 512-H-4

T₃—Output trans.
 T₄—Thordarson power trans. T83R77A
 J₁—RF-IF output jack, Bud
 J₂—Diode input jack, Bud
 J₃—Audio input jack, Bud
 J₄—Audio output jack, Bud
 SW₁—SPDT toggle, Arrow
 SW₂, SW₃—SPST toggle, Arrow
 6" dynamic speaker
 Par metal cabinet



RINGING THE BELL

by

SAMUEL C. MILBOURNE

Home Repairs vs. Shop Repairs

“TO do or not to do—that is the question!” Yes, even old man Shakespeare’s character had his problem of choosing between two alternatives. The problem of whether a serviceman should or should not make repairs in the customer’s home is one which still can bring forth some heavy arguments on both sides.

This is a question of *business policy* and should be treated as such. Inasmuch as there are usually three sides to every question—your side, the other fellow’s side, and the right side—we will take our usual dive off the deep end and attempt to state our personal views on the matter.

First, let us tackle it from a “review” angle. In the beginning of radio servicing, the serviceman was not blessed with all of the servicing aids he now can use. His tools were usually those of the electrician and his stock was confined to a few tubes, condenser blocks, etc. Life was sweet and repairs were considerably more lucrative. The aerial hung high and each repair call could be turned into an impromptu science lecture (including dining-room table demonstration). So long as he didn’t spill battery acid on the front room rug, or talk disparagingly of the customer’s latest aerial eliminator, the serviceman was welcome to set up “camp” temporarily in the middle of the parlor and do any operation on the set he desired, from a radio tonsillectomy to a battery or tube rejuvenation.

Radio servicemen were a race apart. They were the original “*Supermen*,” coaxing entertainment (?) from the *darndest* collection of knobs, dials, wires, etc.

However, into this serviceman’s Eden came the Snakes of *suspicion* and *volume production*. People began to question servicemen as to *why* the charges were thus and so. Receivers became much cheaper in price. Service charges tumbled and tubes (the best profit-makers a serviceman ever had) became cheaper and, oh, so varied in types. Sets became complex, cantankerous and downright *difficult* to repair. Test instruments helped, but test instruments became large, heavy and remained fairly delicate. To complete the deterioration of this Eden-like existence, the \$9.95 set was thrust upon a waiting world.

It all added up to trouble—in large hunks—for the serviceman who still

adhered to the custom of repairs made in the customer’s home.

People were no longer interested in hearing about the “innards” of a radio receiver. They either were bored, or they had a cousin who, they were sure, knew more about it than the serviceman would ever know. They no longer thought that the tableau of a serviceman crouched on the parlor rug in an attitude of prayer, with all his tools, parts, tubes and instruments around him, added one iota to the home decorative scheme. They were interested in (1) getting their radio fixed “yesterday” and (2) paying no more than one-half what the job was worth.

Editor’s Note: Mr. John Rider, in his column “As I See It” covers another slant on this subject. This article, as well as Mr. Rider’s, is most timely in view of the statements made recently in READER’S DIGEST.

So as not to prolong this discussion any further than necessary, let us give you the definite conclusions by which we reached *our* decision to stop repairs in customers’ homes.

(1) If the repair was to be made to a midget or other small table model, the repair cost must be as low as possible else we would lose the repair. It must be as high as possible, else we would not make a profit. Thus, we felt that we would rather make the customers deliver and pick up their small radios so that the time for which we charged them was *working* time, not *delivery* time. In this manner we saved a good deal of time “running around” and applied it to profitable bench work.

(2) Inasmuch as the radio public has not been educated as to what a radio serviceman’s time is worth, we felt that a more equitable charge could be made if the work was done in our shop, rather than in a customer’s home. The finding of an intermittent condition might necessitate the replacement of only one condenser, but the physical size of the part might seem very small as compared to the cost of the time necessary to find it. Also, we found by bitter experience that it cost \$1 to \$1.50 overhead every time we touched a set and this must be paid on *every* set even though the repair was limited to the replacement of a tube which took but a moment’s bench time.

(3) We knew that a better repair could be made in our shop than in the customer’s home because of the tools, test equipment and stock at hand. We knew that shop repairs took less time than home repairs because of the convenience of these same items.

(4) We knew that customers feel that if a repair was made in their home, it was (to them) a *minor* repair. If the same repair was made in the shop it was a *major* repair. We tried not to have *minor* repairs—not because we had any intention of overcharging our customers—but because we knew what we must get from each repair to stay in business, and this amount was more than the customer thought a “minor” repair was worth.

(5) We knew that when we got a radio set on our bench, we could check it more thoroughly and in this manner we could be assured of a minimum of “call backs.” As we guaranteed our work for 90 days, we felt that we were taking much less of a chance in doing so if we had the set in our shop for a thorough check-over.

(6) We honestly tried to do a good repair job on *every* receiver and this must, of necessity, include a realignment (or at least a check of the existing alignment). We felt that by the time we carried all this equipment into a customer’s home and made her afternoon hideous by the whistles and cat-calls attendant to a re-alignment, we would be *persona non grata* from there on.

Thus, we do no work in the customer’s home. The set is repaired in our shop—or else. (Or else some other serviceman gets the job.) So far, we

(Continued on page 47)

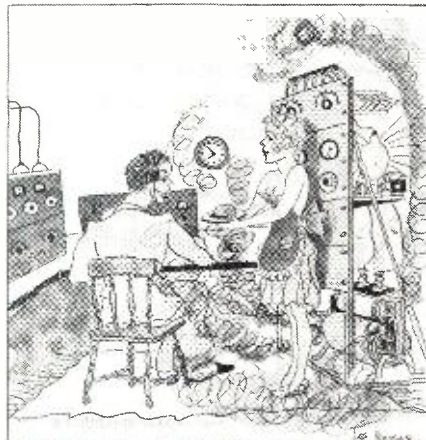

“Smells good, dear. What is it?”

THAT America is awake, alert to the acute problems of the nation is more than evident in industry and home today. With uncanny preciseness, remarkable solutions have been effected to give our nation the immediate help she needs for national defense. And within the scope of industries who have risen with such determination to aid defense, we find radio.

Faced with the Herculean task of suddenly finding suitable substitutes for parts and materials, to afford releasing of essential defense metals and materials, the radio industry has come through with flying colors. The new receivers and accessories of 1942 more than attest to that. With ingenuity, typical of radio engineering in this country, the substitutes consummated afford improved results, rather than substitute results as many feared.

The variety of metals and materials used in manufacturing radio receivers, parts and accessories is most extensive, as the chart on this page shows. Thus, with the intensive defense campaign calling for the production of 50,000 airplanes (in addition to the 500 heavy bombers per month recently ordered by the President), 130,000 aviation engines, 17,000 heavy cannon, 25,000 light cannon, 13,000 trench mortars, 33,000,000 artillery shells, 300,000 machine guns, 400,000 Garand semi-automatic rifles, 1,300,000 Springfield rifles with bayonets, 113,000 motor trucks, 25,000 trailers, 106,000 field telephones, 144,000 miles of telephone wire, plus hundreds of ships, thousands of tanks (13 and 26 ton types), in addition to countless other necessities, imperative to defense, it is clearly evident that the subsidized use and release of many of these vital metals must prevail, small as the quantities may be, in some instances.

This conservation is imperative, in spite of the natural rich resources of our country, and for a variety of reasons. Take the case of aluminum, for instance, where shortage problems are causing plenty of worry. Yes, we have plenty of bauxite, from which aluminum is formed, but, we don't have the necessary power or facilities to produce it. Probably the greatest cause of the trouble has been a lack of rain. With two years of scanty rainfall to account for, the big dams on the Little Tennessee have been unable to supply the terrific amount of power necessary to produce aluminum (10 kilowatt hours for every pound). And unless rainfall increases over the watersheds of the Tennessee and its tributaries, the aluminum situation down here may not look much brighter. To counteract this, the "save power" move has been started. This move is also intended to help production of other metals, requiring huge power drains. In the south, the move has been under way for some time. Streets of Atlanta, Birmingham, Knoxville and many other cities in this area, no longer have bright show windows. In front of drug stores, will be found old time kerosene lanterns, in place of the super-neon signs. Theatre signs have been dimmed, restaurants have "candle-light" suppers and homes are sprinkled with candle light.

The prolonged drought in the South, cutting down reserves of hydroelectric power, has prompted recommendation of the addition of reduction plants in Arkansas to produce 100,000,000 pounds of aluminum; in the Grand Coulee area of Bonneville, where two plants of 140,000,000 pound production are to be erected; in upper New York State where two plants of 150,000,000 pounds capacity are to be erected; in Alabama, where one plant of 100,000,000 pound capacity will be built; in California where a 70,000,000 pound capacity plant is in the making and in North Carolina where a 40,000,000 pound

National Defense and the 1942 Radio

by **LEWIS WINNER,**

New York City

Authoritative data based on a recently concluded tour of over 100 manufacturing plants, in 12 states, shows some interesting findings.



Reproduction of a late OPM poster.

capacity plant will be built. This, in addition, to the plants already in operation, should help to solve the problem, provided rolling mill facilities are available. This important problem, too, is in the process of being solved.

When it is realized that simple fighter planes use some 7000 pounds of aluminum in their structure and heavier planes, such as bombers, correspondingly more, it becomes quite evident that aluminum economies in industry are most essential. With radio using over 2000 tons of aluminum last year, the industry's contribution by substitution is noteworthy.

Variable condensers consumed over 50% of the aluminum used in radio last year. Thus, the first step was to find suitable materials that would serve in this important capacity. While steel was immediately recommended, too many problems known to engineers from past experience, were thought of as making this suggestion impractical. However, it was not long after the Office of Production Management made its historic priority statement concerning aluminum, that steel condensers made their appearance in the test laboratories of receiver manufacturers. That the condensers were most suitable, is best evidenced by the fact that most receivers this fall will be using them, and with exceptional results. The steel used in most instances has a lead coating, giving it the properties of a soft steel. This new material was, strangely enough, in the process of development for over a year prior to any priority situation. The research was prompted by the desire to develop materials that would be perhaps more suitable and effective. Thus, the new metal is not the result of haphazard tinkering, but rather the result of studious research.

By treatment with special liquids, corrosion is entirely averted in these new condensers. This anti-rusting process eliminates one of the most dangerous problems. Other characteristics of the condenser are

Chart shows what materials are needed for radio items and where obtained.

Source of Supply of Metals		Metals Used in Radio	Metals Used in Radio	Source of Supply of Metals
New York New Jersey Oklahoma Kansas New Mexico Iowa	Montana Idaho Utah Nevada Washington Missouri	ZINC	SILVER	Tenn. Ala. Missouri S. Dakota Colorado Utah
New York Alabama	Georgia Arkansas	(Bauxite) ALUMINUM	TIN	Alabama Bolivia British Dutch E. Ind. Malaya
New Hampshire North Carolina		MICA	GRAPHITE	Alabama Mexico
Pennsylvania West Virginia Michigan Alabama		STEEL	TUNGSTEN	S. Dak. Burma Road (China)
	Illinois		MOLYBDENUM	Arizona Colorado
Georgia Montana	Nevada Cuba Africa	MANGANESE	LEAD	Alabama Iowa New Mex. Montana Nevada Wash. Mexico
Tenn. Alabama Michigan New Mex. Colorado Oregon Montana	Idaho Utah Arizona Nevada Washington Mexico Chile	COPPER	MERCURY	Nevada California Mexico
New Jersey Georgia	Illinois Minn.	IRON	ACETELYNE BLACK	Canada
			MAGNESIUM	Gulf of Mexico (Sea Water)
			NICKEL	Canada
			CHROMITE	Africa Philippines Turkey

less drift and less microphonics, two difficulties that stumped engineers in prior attempts. Since the torque (ounces of weight) is greater, due to the natural increased weight of the metal, these condensers will not be used with mechanical tuners. The rotors will be too difficult to swing, and counterbalances will not be of any assistance. Thus, receivers using mechanical tuners will, of necessity, use permeability tuning with domestic powdered iron in the cores. Electrical tuning systems will, of course, still be able to incorporate these variable condensers.

The innate properties of the steel, causing some elasticity, will prompt strict attention towards alignment and calibration. While the manufacturers will make every effort to attain perfection, tracking problems may become more frequent and thus warrant additional attention on the part of the service man.

In many other portions of the receiver, aluminum pieces will be absent from the 1942 receiver. The i-f shield cans will be either of steel or powdered iron, dependent upon the tuning methods and chassis size selected by the manufacturer. If sufficient chassis space is available, powdered iron shields may be used. These shields are said to increase the Q of a coil considerably over aluminum, zinc or "tin can" covers. The steel containers will be of the same size as the aluminum, and smaller in some instances.

Disappearing from its popular position on the chassis also, will be the aluminum can covered electrolytics. No metal substitutes will be used here at all. Either impregnated kraft paper or cardboard containers will be seen here. And in some instances, plastic tubes will be used. The dehydration problems, which led to the earlier selection of metal cans, have been solved, so that the new type condensers should serve their purpose efficiently. Although wet electrolytics have been used only in few instances in the current models, their absence from the receivers now coming off the line will be practically complete, due to the shortage of aluminum cans. While aluminum foil is still available, it is becoming increasingly harder to get. Substitution of lead foil in paper tubular condensers is accordingly planned. These condensers will naturally be slightly heavier and larger, since lead cannot be rolled off as thin as aluminum.

Permeability tuning which heretofore was most commonly used in auto sets and recently adopted for many F-M receivers, will also become quite commonplace in the household receivers of 1942. Several manufacturers have already indicated that 80% of their production for the fall will use this form of tuning.

Thus far, no substitution has been found for *alnico*, used in p-m speakers, and thus the only alternative has been to use electrodynamic speakers where such a switch, of course, is practical. Such has been the case of the AC/DC sets. In the more expensive models, the electrical deficiencies caused by the changes has been corrected. In the cheaper models, reduction in efficiency as much as 3 db. has been allowed.

It is quite evident from the foregoing that Iron, Steel and Lead have been the standard of acceptance, thus far, for substitution purposes. These three metals are also all on critical priorities list, but the present supply, and anticipated supply is of such proportions as to assure a fairly constant flow.

With the pronouncement that nickel was on the critical list, came the fear that tube production would be stopped. Thus far, production has been reduced, but not sufficiently to cause shortages. Some substi-

(Continued on page 55)



by CHARLES J. SCHAUERS

Aircraft Electrical System

THE modern aircraft radio and electrical installations encountered by the practicing aircraft radio technician often present trouble-shooting problems that test his ingenuity at every "turn of the road." It is conceded that experience and proper training are essential attributes in any highly specialized work; in very few cases will one supplant the other.

The aircraft electrical and radio installations found in modern aircraft today, vary as widely in design as do automobiles; but after all is said and done, they all operate upon the same basic fundamentals. With this thought in mind then, we shall proceed to discuss modern trouble shooting procedure in the aircraft system.

Units comprising the electrical installation aboard most aircraft, consist of: main storage battery; generator; lighting systems, both exterior and interior; distribution panels or main junction box; voltage regulator; reverse current cut-out; master switch and/or switches; starting relays; starter motor; and associated wiring. The ignition system is classified sometimes as an integral part of the main electrical installation. However, we will consider it as having no direct connection with the "centralized power system."

All power (unless a self-contained battery operated set is used), is obtained from the main storage battery and generator system. These batteries may have ratings of from 6 to 24 volts, and ampere-hour capacity ratings as high as 180, depending upon "bank connection." The generator usually is designed for a 50% over-load rating to take care of "starting surges" and will usually be designed to have an output one-half times larger than the highest current requirements of the installation. That is, taking the battery as the "secondary current source" in parallel connection and assuming that it is always fully charged. In some aircraft two batteries are utilized to advantage, but these are usually found on board large aircraft of the multi-engine type only.

Our first trouble, and a very prevalent one, is of major concern, viz., poor battery operation. It is of paramount importance not only because it serves the installed radio equipment but other equipment as well. Improper care of the main battery seems to be the underlying cause of most of the troubles encountered. Water should be added to the battery at least once a week, if the aircraft does much flying, and oftener in the summer months.

Tests with a hydrometer (for specific gravity of electrolyte) should be performed every week; terminals should be coated with grease and connections should be tight. It is said, that low voltage is just as detrimental to the radio apparatus installed, as is high voltage. It is therefore necessary that both the generator and battery be inspected and tested periodically to assure rated output. A "low" battery may indicate its condition in a number of ways. The brightness of lights; sound of dynamotor (no high pitched whine); weakness of receiver output; low transmitter output and low interphone volume all indicate a weak battery in most cases.

In the air, the conditions noticed above would necessarily indicate improper generator action if a heavy load is imposed on the source. Too, the voltmeter, usually incorporated in every installation, will in most cases show low voltage readings. When the

aircraft storage battery is in the shop for its 60 day examination, it should not be charged quickly by the application of high current. Rather, it should be trickle charged and immediately after this operation, it should be load tested with the approved type instrument. The load test is the most reliable of all tests to show the exact worth of the battery; although the hydrometer test is taken to be the best by some technicians. Overcharging of a battery is to be discouraged, as well as undercharging, although the former will do no permanent harm.

The generator should be inspected for wear of commutator surfaces; the alignment of the brush holders should be checked as well as the wear of the brushes and lubrication. Very little trouble will be had with the average aircraft generator if the voltage regulator and the reverse current cut-out are operating properly. It would be wise, too, to check the generator condensers; these sometimes overheat with resultant breakdown of the dielectric material causing shorts.

The adjustment of the voltage regulator should not be attempted by the novice, nor should the reverse current cut-out adjustment be performed by one who has had no previous experience in this work; reasons are apparent.

Under no circumstances should fuses that do not have the maximum current ratings be installed in the terminal junction box. Lower rated fuses than those required are about as troublesome as those having over-age ratings. On heavy loads (maximum drain) the low rated fuses will blow; and over-loads will not cause the over-rated fuses to blow with consequent damage to equipment, unless the equipment itself is fused.

Where a balanced charging system (two generators-two batteries) is utilized, care should be taken to see that inputs are balanced. Where one ammeter shows a high rate of charge in contrast to the other showing a low rate of charge, the former reading indicates a low battery or a heavy drain. Therefore, the other generator should be balanced with respect to the first in order to equalize the loads. In many instances "no charge" indications will in turn give way to indications as to the worth of the reverse current cut-out. Points stick and burn open or the spring tension is incorrect. Correct adjustment of the reverse current cut-out plus regular cleaning inspections will eliminate most troubles attributed to this unit.

When replacing any wiring in any conduit in an aircraft installation, the same size wire as was removed should always be used, because the size has much to do with load requirements. In case a "wire burnout" occurs, larger wire should be used, space permitting, but *never smaller wire*.

The aircraft electrical starter (engine) is sometimes a source of trouble. A complete understanding of DC motor operation is essential in order to cope with each trouble that arises in this specific part. In most cases, high spot brushes will be a source of trouble, as will dirty commutators, and loose connections. Sometimes, windings will be found burned and shafts will be found "frozen," these conditions are due, in part, to prolonged operation on "cold starts." Due to the fact that these starter motors must turn at very high speeds, prolonged operation will, in many cases, cause excessive heat.

(Continued on page 56)



Connections to the amplifier are made at the terminals mounted on the side of the chassis.

Beginner's 14-Watt Amplifier

by L. M. Dezettel

Allied Radio Corp., Chicago

New circuit design plus added features are included in this efficient amplifier. Parts are inexpensive and construction is simple.

THE beginner experimenter has been left out of the picture too often when it comes to describing the construction of an amplifier. It is to you fellows who are not too thoroughly acquainted with the meaning of "db gain" and "frequency response" that this article is addressed. The construction of this amplifier is simple. The cost low. And the results will be equal to those obtained by the more technical minded constructor.

The amplifier operates from 105-125 volts, 50-60 cycles a.c. It has sufficient gain for use with a crystal or other high impedance microphone, and when used in conjunction with the proper output transformer, will operate one or several speakers. This combination makes an excellent public address system for covering an indoor area of about 15,000 square feet. Outstanding among the many features are: Push-pull beam power output with full 14 watts peak audio power (12 watts undistorted), inverse feed-back for highest fidelity, balanced phase-inversion, contact potential biasing of the first tube, and three inputs—microphone, phonograph, and radio, each one operating independently. The superior single-ended metal tubes are used as mi-

crophone amplifier and phase-inverter.

Front controls are: microphone gain, phonograph gain and tone control with on-off switch. No volume control is used for the radio input, because the volume control in the receiver is used when that input is hooked up. The four-contact socket on the back takes a standard four-prong plug for a speaker extension cord.

The chassis listed in the parts list is available already punched and formed and is made of heavy gauge steel, finished in baked-on black crackle. Control markings are silk screened onto the front of the chassis.

Assembling the Amplifier

All parts, except the small tubular condensers and resistors, are mounted on the chassis as indicated in the pictorial diagram. Be sure that tube

guide pin slots are facing the front of the chassis. All sockets are mounted from under the chassis, while the three input strips are fastened onto the outside.

When wiring the amplifier, two important precautions must be kept in mind. All leads must be laid down close to the chassis. Leads from the input and the output of the amplifier should be kept as far from each other as possible.

Do not make connections any longer than necessary. If pigtail leads on the condensers and resistors are longer than needed, clip them off to the desired length.

Solder all connections carefully with a well-tinned hot iron and resin core solder. If solid core solder and separate paste is used, no more than a

dab of paste should be used on each connection. Apply the iron to the connection and hold it there until the connection is hot enough to flow the solder.

Work slowly and carefully. Check off each connection on the diagram as you wire the amplifier. When you have finished, go over your work once more. A few extra minutes spent in wiring and checking may save hours of searching for trouble later.

The diagram shows the output transformer leads connected to the speaker plug to indicate the proper prong connections. For public address work, you should have at least 25 feet of 3-conductor cable connected between the transformer and the plug. The transformer is mounted on the

speaker which saves much space.

When you use more than one speaker, be sure to maintain proper matching to the transformer. The average speaker, for instance, has a voice coil impedance of 8 ohms. The transformer listed here matches this voice coil impedance to that of the tubes—7000 ohms. The diagram shows the proper transformer taps. Where two such speakers are used; however, their voice coil leads are either wired in series and have a total impedance of 16 ohms, or are wired in parallel and have a total impedance of 4 ohms. Different transformer secondary taps are then used. In the first case they would be No. 2 and No. 6. In the second case, they would be No. 1 and

(Continued on page 47)

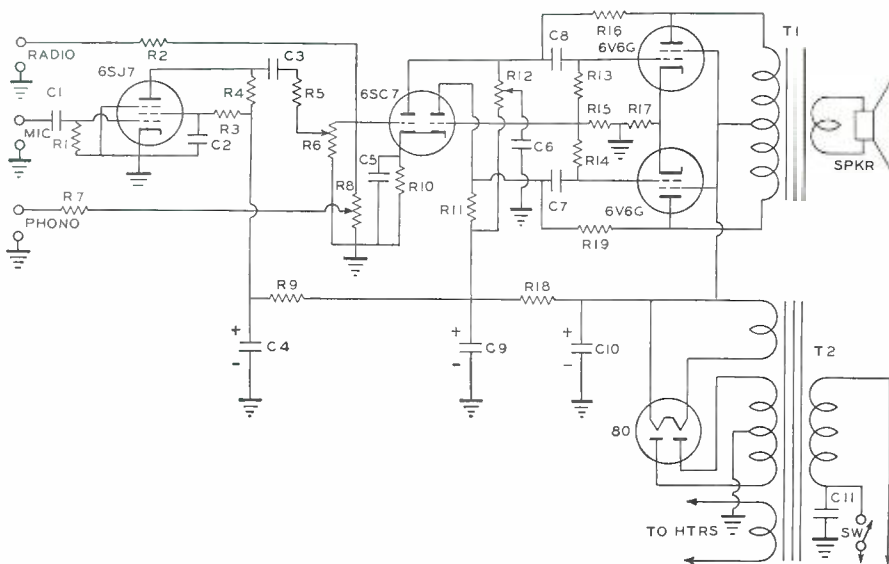

- C₁—.005 mfd., 400 v. paper, Knight
- C₂—.1 mfd., 400 v. paper, Knight
- C₃, C₇, C₈—.05 mfd., 400 v. paper, Knight
- C₄—.16 mfd., 25 v. electro, Knight
- C₅—.10 mfd., 25 v. electro, Knight
- C₆, C₁₁—.01 mfd., 400 v. paper, Knight
- C₉, C₁₀—20 mfd., 450 v. electro, Knight
- R₁—5 meg., 1/4 w., Knight
- R₂, R₁₃, R₁₄, R₁₆, R₁₇—500,000 ohms, 1/4 w.
- R₃, R₄—1 meg., 1/4 w., Knight
- R₅, R₁₁—250,000 ohms, 1/4 w., Knight
- R₆, R₁₅—100,000 ohms, 1/4 w., Knight
- R₈, R₉—1 meg. pot., Knight

- R₁₀—50,000 ohms, 1/4 w., Knight
- R₁₂—1500 ohms, 1/4 w., Knight
- R₁₂—250,000 ohm pot. with switch, Knight
- R₁₇—300 ohms, 3 w., Knight
- R₁₈—20,000 ohms, 1 w., Knight
- T₁—Output trans., Knight B9593
- T₂—Power trans., Knight B11614
- 1—RCA 6SJ7, 1 RCA 6SC7, 2 RCA 6V6G, 1 RCA 80
- 1—10x6x3" punched chassis Knight N2339
- 4—Octal sockets
- 2—4-prong sockets
- 1—4-prong speaker plug

Underchassis view shows tube sockets lined up near front of chassis. The plate-and-filament transformer is farthest from the pre-amplifier stage.

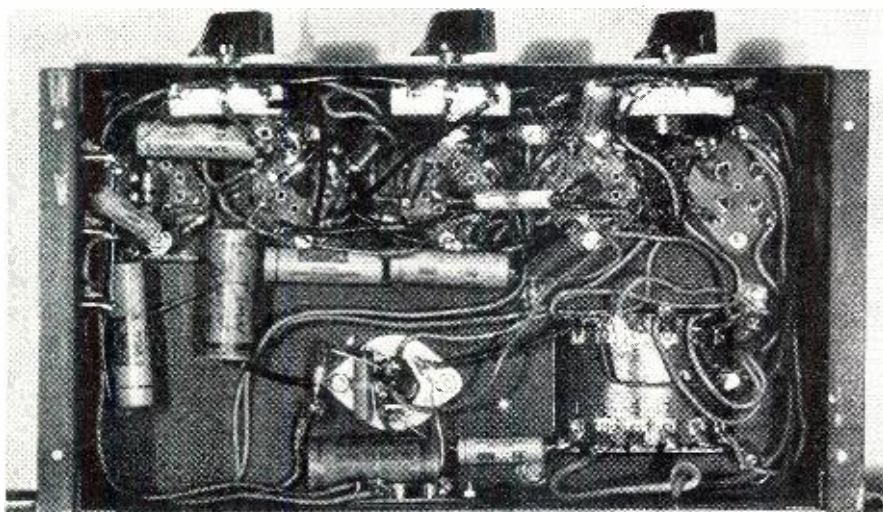

NEW TUBES

RCA announces 5 new tubes as follows: RCA-6SL7-GT, Twin Triode Amplifier, RCA-1631, Beam Power Amplifier, RCA-1632, Beam Power

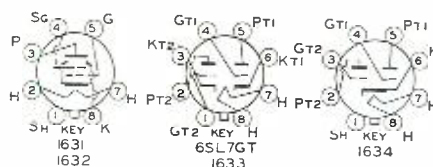

Amplifier, RCA-1633, Twin-Triode Amplifier, and RCA-1634, Twin-Triode Amplifier.

The 6SL7-GT is a twin-triode amplifier of the high-mu ($\mu=70$), single-ended type with separate cathode terminals for each triode unit. It is recommended for use in resistance-coupled circuits as a voltage amplifier or phase inverter. This high-mu type, like the 12SL7-GT, has separate cathodes which are brought out to terminals in the base and, therefore, offers much greater flexibility from the circuit designer's standpoint than do other high-mu twin-triodes having only a single cathode connection.

The 1631, 1632, 1633, and 1634 are special-purpose tubes primarily for added convenience in the design of special storage-battery-operated mobile equipment. The 1631 and 1632 are intended for applications critical as to uniformity of characteristics, while the 1633 and 1634 are for applications critical as to matching of the two triode units. The 1631, 1632, and 1634 have 12.6-volt heaters and the 1633 has a 25-volt heater.

EMERSON adds 6 new tubes to line. Six tube types, relatively new to distributors, dealers and servicemen have been added to its renewal tube line, announces the Emerson Radio and Phonograph Corporation, New York City. While in the category of new tubes for replacement purposes, these types have been used in fairly large quantities as initial equipment, and renewal demand is already being felt.

Types added are: 12SF7, a diode-super control amplifier pentode, 6SS7, a triple-grid super control amplifier, 1SA6GT, r.f. pentode, 1SB6GT, diode pentode, 3B5GT, beam power amplifier, and 117Z4GT, half-wave rectifier.

"June completes one year since the introduction of Emerson tubes in the renewal field and as initial equipment in radio receivers", stated Jack Geartner, Assistant Sales Manager, in charge of tube sales, at a recent meeting. "Many millions of Emerson tubes are now in use in every state and in all countries throughout the world that have been open to American trade. A natural replacement market has already resulted and is being augmented steadily by factory shipments of thousands of additional Emerson tubes in sets each day."



w1ngs & w1lp.



Ham Chatter



Xyl of w6qqu.



k6pin builds a beam.

Mountain 112 Mc. site.



FOR years the Radio industry has been greatly overcrowded with the inevitable low wages and poor working conditions. However at the present time almost all branches of the industry are in dire need of trained men. The Defense agencies have taken many of the skilled civilian workers, creating numerous openings in the manufacturing field. Many hams now working at other forms of work less pleasant would do well to investigate the possibilities of technical schooling to fit themselves for these jobs. The fact that you hold a ham ticket tells the prospective employer little. This is an age of specialists and the man who knows a little more than the next fellow about some particular subject has a very definite advantage. Your ham background is an excellent foundation for further training in Radio. The man who has his hobby for his work is usually a far better worker than the one who works to eat.

The Hamchatter Editor.

From the Mail Bag

DEAR OM: In looking over the Ham Chatter Column I see a lot of comment on power. Also a lot of new hams doing so well in a week or so after they get their tickets. How many are using low power? It looks like the boys are getting commercial. I wonder how many of the boys conform to the FCC ruling that the minimum amount of power be used over a given distance to carry on satisfactory communication? I would like to see that rule enforced. It doesn't seem fair to me that the boys that can have hi-power should be using a kilowatt to work Gary from Chicago and putting a sig in here that makes it impossible to work locals thru. I, myself, have been on a good many years and have no trouble getting out on any of the bands and I seldom use more than 25 watts input. Of course I have spent some time getting the ant cut to the proper lengths for the freqs I work on. I do admit there are times when fone doesn't get out so far on 160 and 75 but I never fail to get the qso's up to 250 miles and I run only 15 watts input on these bands. I would like to see all hams limited to not more than 100 watts input on their rigs. In this way it would make it better for all the hams. Qso's in New York

w1hjp, w1mfy, w1lmu.



wouldn't be ruined by qrm from a W6 or vice-versa. You could always work the boys near you then and if you wanted DX, stay up or get up in the wee hours of the morning. I almost forgot that I should tell you mi call, it is W8BJD. Also am usually known as "Red." I don't expect this to be printed, but would like to see some comments on this minimum power ruling. Also in closing and as a parting thought I would like to know how come so many of the hams on the fone bands can't copy cw at all.

73, "Red" W8BJD.

DEAR Hamchatter Ed: In recent issues there seemed to be quite an argument over the advisability of using 'phone in the AARS. With all due respect to the opinion of several of the fellows to the effect that it is possible to handle messages faster with 'phone, and pointing out the abundance of 'phone operators as opposed to the comparative scarcity of good, high-speed cw traffic men, I cannot believe that 'phone can ever replace cw in Army operations except in a very few, specialized cases of a comparatively limited nature. To find out the most efficient way of doing a thing, merely look to the fellows who make a living at it. I challenge anyone to produce an example of any commercial traffic system using 'phone. There just aren't any. Is that because the commercial ops are all old-fashioned, or that they can't afford to install 'phone equipment? Of course not! The bare facts are that 'phone just isn't efficient in message handling. Can you imagine a press dispatch coming in like this, "The Bolsheviks are falling back on the Voroshilovgrad sector," and any op taking that down accurately? Not only would this system be less accurate, but also slower even when common words are being sent, because the receiving operator would have to take the incoming message down in shorthand, then type it out later, wasting valuable time. And as a third point in discussion, in Army work where a minimum of power is a necessity, any ham knows that cw will cut through more hash, line noises, and static for a given power, cover longer distances, and be more intelligible than 'phone. So, it seems to me, that as "The Sergeant" said in the July issue, it all boils down to the fact that these " 'phone boys are just too lazy to learn code more than 13 wpm" and yet want a radioman's job in the Army. 73's, W8UOP.

SOME gossip from W8UPO: W8QPJ, formerly of Republic, Ohio, is now right in his element grinding xtals in

w3dnu.



Carlisle, Pa. We're mighty glad to hear you like your new job, Harry.

Since W9LTR, of La Grange, Ind., raised his ant, he lays a better sig in here than formerly—if such a thing is possible. Cal always has had one of the most consistent, best-sounding sigs on the air, me thinks.

W8QYY, who recently received his Class A ticket, now alternates between 75 and 160. Apparently the op isn't too high brow to return to the 160 m band occasionally for a rag chew with his jughead pals of the good ole days. Ain't it the truth, Ed?

W8ATV, operating fixed portable in E. Canton, Ohio, just put a complete new transmitter on 75 m phone. He confesses that he ran into plenty of trouble with an 807 buffer. It's evident that you have the difficulty well under control, Bob, 'cause your sigs sound fb from here.

Some cw hound remarked in scathing tones that anybody can operate phone. Hmm, could be, could be. BUT it isn't every person who has the patience—as well as the intestinal fortitude—to glue his ear to the receiver and practically go into a trance in the attempt to pull weak phone stations thru the arm—and not end up fit to be fitted for a straitjacket. After all, it takes two to make a qso. Receiving cw is usually comparatively easy, but "going goofy" and "trying to pull in weak or fading phone stations" (which is what we all are at times) is synonymous. What? Do I hear loud shouts of controversy? Oh, well, let's skip the whole thing.

It's reported that W8FHB, the former Hollywood bachelor, who is now married and living in Toledo, has a small rig on the air. We've been listening around for you, Paul, but so far have failed to hear you.

According to a post card sent to us by W8TAO, from Scott Field, Ill., Dewey likes Radio School and is getting along fb. However, he admits that being an SWL is kinda hard to take. The 400 watter formerly at his disposal is now being operated by W8CHS, Findlay.

Speaking of endurance, how's this for an example? W8RXJ spend about 1½ days steady work building himself a speech amplifier recently. Starting at noon, he worked until late at night; then got up early next morning and finished the job at noon. That sure took a heap of wiring! It's the eighth speech amplifier Gene has built in the last four years, so he's had lots of experience. Maybe that's one of the reasons why he gets such good results.

W8UPIE lacks only Rhode Island for a W.A.S.

July 20th was the date set by W8VDJ for erecting a new 130 ft. vertical ant.

W8USR has his new 807 rig on the air. Result: He's working out and really getting himself some good reports. 'Atta boy, Will.

W8IAO is now working on the B. & O. R.R.

We aren't hearing much from W8SHQ, the great outdoor man, these days. Possibly it's because the groundhog season has opened. Are you having any luck, Lewy?

What's happened to W8TSB? He's probably pounding brass down on 80 m. Hey, Ed, how's about climbing back on your favorite 160 m kc and giving us a buzz?

Two brand new hams on 160 are W8WCB and W8WBX, both of Toledo, Ohio. Greetings, fellas.

FROM our reporter W4GFF:

Quite a few of the Greenville boys and gals took in the Cornelia, Ga. hamfest and had loads of fun.

W4FCW Doc is laid up in hospital at Ft. Jackson S. C. wid bad foot—we all wish you a speedy recovery OM.

W4DAM-CW worked 40 hrs. in SS contest on CW and came in second. Also tried 2 hrs. on fone and came in FIRST (S. Carolina only).

Wonder what will happen next? W4BWC

Field Day camp of w9vsx/9.



Paul finally got back on the air after long absence. Welcome OM.

W4HEY Posey is trying his luck on 1.75mc. CW. We understand he handles most of traffic for S.C. boys and gals. Over S.C. trffic net which was recently formed on CW but the fone net has been going strong for the past 1½ years. Well more power to U boys.

W4CSP, Linn, has been strutting his stuff since he joined the AARS. Was made member of rag Chewers Club (this reporter is also member of the dear Ole RCC) appointed emergency Coordinator and OPS for S.C. Was made member of S.C. emergency net, voted secretary of Greenville Amateur Radio Club and is also member of that famous KNOT HOLE net. Keep up the gud wrk Linn.

W4HGB, George, is still on 160 fone and is active member of various trffic nets. W4CHD, Otis, is doing veri FB on 80CW and has made quite a name for himself as a trffic wizzard. W4AIS, George, is veri proud owner of new receiver, which happens to be a HQ 120x.

Ann the XL, who took the class B exam 9 weeks ago still has high Hopes of being on the air veri soon (hope her luck) in fact the transmitter is ready now but no ticket. Well ANN no news is gud news. Hi!

W4FHE has changed QTH to Florence S.C. and now the town can boast abt two HAM stations, the other is W4GUJ who's handle is John.

W4FWO, Irving, changed QTH to Columbia and we hear he is now OPS, and is trying to improve code speed. Lot's of luck.

Well, Field day is over and the GARC really did fine. Worked 120 stations wid

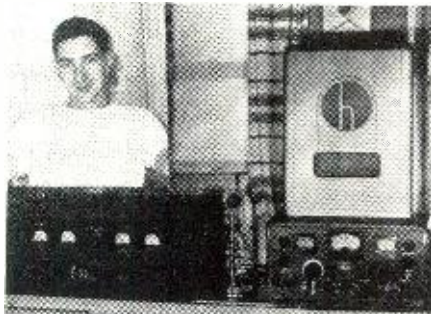

w6spq ex-w4pak.

Meissner signal shifter wid 15 watts, the ops ran into some bad luck as it rained all da and nite, and was using balloon supported antenna that is until it burst abt 60 ft. in the air after abt 3rd. refill Hi. But that "OLE" ham spirit was there and all in all it was funny. Everi body seemed to have lots of fun. The ops were W4EJH, W4KZ, W4GFX, W4FNS, W4DAM, W4HEY, W4CSP and loads of others.

W4BPD, Gus, came in first in S.C. contest on CW. Seems as if he es W4DAM ran a veri close race. The gang is proud of you Gus.

W4GCW, Newell, has his 809 on 1.75mc. fone and has a veri FB signal.

W4CCU, Joe, is still swelled up wid pride over the swell reports He gets wid new rig.

W4HKI is NYA station heard everi after noon wid whale of a signal from West Columbia, S.C.

W4GPN, Walt, is still waiting for that class A ticket he took exam in Jan. Maybe it will show up, Walt. Hi.

W4ETC, Lewis, is having trouble wid new rig these daz. Seems as if he can't keep final tubes all in one piece. Hi. Sounds bad, Lewis.

W4FUL, Perry, is now on 40 CW and from what we hear he likes it better than 160 fone. Shouldn't do it. Shouldn't do it. Hi!

W4EOZ, Joe, of Morganton, N.C. Seems veri sane, considering the fact that his QTH is the same as the N.S.'s bug house. Hi! No hard feelings we hope, JOE.

W4GHO of Salisbury, N.C., is still carrying on his nonsense wid the fellows on 75 and 160 fone. But we do like to QSO U Ed.

W4FNC is operating both 1.75m.c. es 3.9mc. fone.

W4CEL is employed as inspector at local camp.

W4HHO is call assigned to Charleston, S.C., Radio Club.

W4EJK is veri active on 160 fone.

W4HAZ has a 100 watts to a 809.

W4GXB, Greensborough, N.C., is president of Greensborough Radio Club who's call is W4GNF, es TEX also holds Proficiency Certificate for 35 WPM, which is fine business.

W4EIW has passed his class A and is on 3.5 and is on 14mc. fone. We all wondered where you were, HERB.

W4HDK, located at Sanatorium, N.C., is so far as known the only and First licensed YL op in N.C. but is not active at present. Better get on the air, Gal. Hi!

The Yankees are really pouring into the south. So seems as if W2BQH, W2JOC, W2GBY, W1MJ, W3GEF are at Ft. Jackson, S.C. But we welcome U fellows. We'll go NORTH some time. Hi!

W4BSS, John, seems to have disappeared from the air lanes—come out of hiding, JOHN, es let us know what's up.

W4DSL (Maiden, N.C.), has been found. It seems as if he has changed his QTH to Ft. BRAGG, N. C. He's in the U.S. Army now. Hi!

W4EFE, formerly of Newton es Hickory, N. C., is now working for Tampa, Fla., State Police. Boid, do you mean you are actually on the out side looking in?

W4EQJ, Carl, is active on 160 fone es works out FB wid his 30 watter at Maiden, N.C.

W4EKR of Hendersonville is active in the navy as RM3-c. Seems as if Walt bumps into radio everi time he turns around. Hi!

W4EFX is also in the NAVY as RM-3c. Bull es Walt write back some interesting experiences they have in port, uh huh. We thought so.

Bonnie Jackson, That GAL that operates W4GEX, shore do get around. But it seems as if your reporter has a hard time finding her on the air. So Bonnie, loosen up and give us your frequency and time that we might hear you on. We tri to copy the news just as we receive it and we hope that everi one is pleased. Hi!

W4FFI, Bob Williams, is getting out fine business wid his vertical es if he gets better wid it I know some other fellows that will be using verticals, eh Bob.

W4GUI at Jacksonville, Fla., slays 'em wid dat hi-powr of his es QRM or QRN is no bother to him.

W4PX of NAVAL base at Jacksonville, es W4FDE, also at the base, are supposed to be on the air at the time of this writing but we have not heard 'em. How's abt it, Fellows?

Marie, the better half of W4FDE, has the MUMPS es we wish her a speedy recovery.

W4GZC, Bill, has moved to Waycross, Ga., es is kicking 25 watts of a single 616 in the final.

W4HFK is back in Cordele, Ga.

W8KJR/4 is active on 75 metres. How's abt a call, Ed? W4FAH at Eastman, Ga., is still putting out a whale of a sig on 160 mtrs.

If any one ever hears POP, W4FDJ at Lions, Ga. The Ole man of the SWAMP, tell 'im Hello, es that W4GFF would like to get the news pertaining to all the U.S. Army nets as he is Boss of them all. Hi!

NEWS from the deep South by W5IKP: W5GIA of Metairie, Ia., one of the best hams in town, has left town to work as radio op. for the gov't.

W5HOU of Metairie runs about 400 watts on twenty meter phone using an HQ12OX receiver and a deluxe home made ECO.

W5FMO of Metairie is also working twenty these days, with very nice signal.

W5ECO is another Metairie resident along with W5DAQ.

W5HRD, W5HJC, W5HCO run around 30 watts on 10 meter phone, all using similar rigs with 6L6 finals.

W5IN is still running almost one KW to his three element rotary beam on 10 meter phone and really puts out a terrific signal. Burt plays the sax with Johnny Detroit's band.

W5IZX is still playing around on 160 phone with 25 watts input.

W5IUG has a dandy looking rig. Doc just finished building a small rig to work the local fellows with.

(Continued on page 58)

w9sxz & w9clb work F. D.



WHAT'S NEW IN RADIO

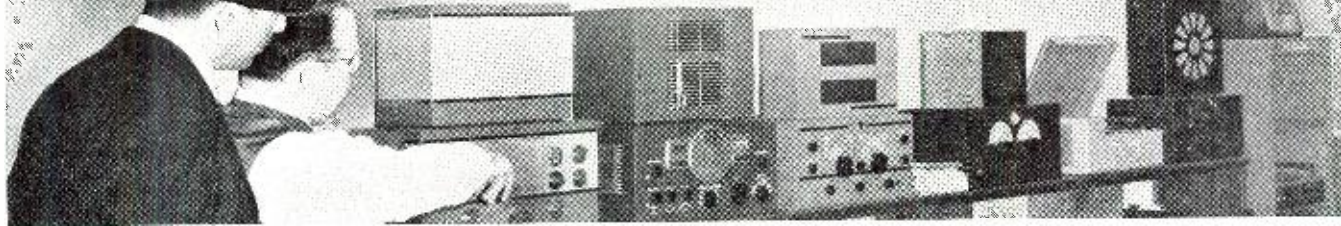

New G.E. Radios Announced

Supporting its conviction that the small radio receiver, or "extra set," currently presents users with a most logical and enjoyable extension of radio services and dealers with a great profit opportunity, the *General Electric* radio and television department, Bridgeport, Conn., has announced 19 new receivers for 1941-42, of which 18 are table models and one a console. These,

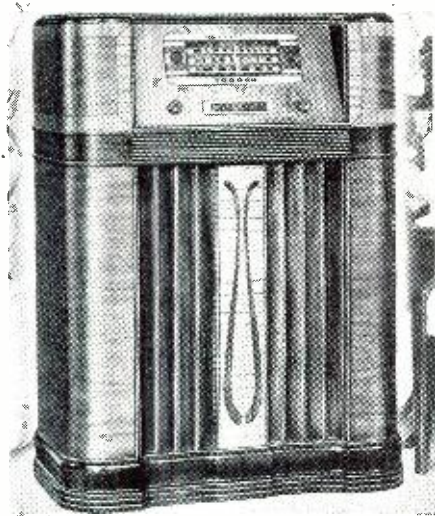

with one other table model, a table-type radio-phonograph combination, and ten battery-portables announced earlier, make up the new G-E "L" line to date, although A. A. Brandt, sales manager, has announced that a half-dozen additional small sets, two consoles, and several radio-phonograph combinations will be introduced later. The latter group will include *General Electric's* new frequency-modulation equipment.

The larger-than-usual number of table models have been designed by G-E engineers to meet a recognized demand for small, high-quality, trouble-free radio instruments which are simple to operate and will win a place for themselves throughout the livable areas of the home. Styling, which ranges from modern and colorful plastic sets to both unusual and conventional wood-encased models, lends itself to kitchen, bedroom, playroom, nursery, terrace, bathroom, and office. Modest dimensions, together with modest prices, particularly recommend the new sets as such necessary auxiliaries to modern living.

New Electric Tool

Here is a versatile tool for the radio man that will fulfill a host of applications in the shop or experimental laboratory. It is the new "Whiz" electric tool made by the *Paramount Products Co.*, 545 Fifth Ave., New York. It drills any hole up to $\frac{1}{4}$ " in any material, including steel and grinds with

a large 4" wheel or small mounted wheels in a variety of shapes to fit any job. It may also be used to sharpen drills and tools. Many accessories are available so that the Whiz may be used for many other every-day jobs around the home as well as in the shop.

It is also capable of sanding, brushing, polishing, sawing, shaping, etching, engraving, and carving. This all-purpose tool is available in two models: a standard model and a two-speed model. Complete information and specifications may be had from the *Paramount Products Co.*, 545 Fifth Ave., New York City.

2½ Meter R.F. Choke

A new 2½ meter band R.F. Plate Choke Z-O has been added to the well-known series of radio frequency plate chokes made by the *Ohmite Manufacturing Company*, Chicago.

All the important features of the *Ohmite* chokes are present in the new unit. It is single layer wound on a low power factor steatite tube, and the winding is covered with moisture resisting insulating material which protects the wire. With this type of construction, there is no possibility of the winding collapsing under operating or overload currents. Also, because of the single layer winding, the voltage differential between adjacent turns is low and the possibility of breakdowns between turns is eliminated. The design is such that no portion can resonate independently from any other portion to cause energy absorption at fundamental or harmonic frequencies.



The new Z-O R.F. Plate Choke, because of its small size ($1\frac{1}{4}$ " long and $\frac{1}{4}$ " tube diameter) is especially applicable to transceivers, 2½ meter mobile transmitters, and therapeutic and diathermy equipment. Mounting is by means of the wire leads. Other sizes available are for the 5, 10, 20, 40, 80, and 160 meter bands. For further information, write to the *Ohmite Manufacturing Company*, 4835 Flournoy Street, Chicago, U. S. A.

"Floodlight Tone" Makes Debut

"Floodlight Tone," an acoustical innovation that floods the room with sound at new standards of realism, and new horizontal "Studio Controls" make their debut in the new series of *RCA Victor* radio models announced today by Edward W. Butler, Manager of the Radio, Television and Phonograph Division of the *RCA Manufacturing Company*. The model shown is 29K-2.

This impressive realism is achieved by supplementing the customary 12-inch loud-

speaker with a smaller and especially designed *RCA Victor* "High Frequency" speaker. The result is a tripling of the area of full tone-projection in a room to achieve a realism radio engineers have been striving for ever since the first radio waves were projected into the ether.

Many other engineering improvements have been built into the new sets, Mr. But-



ler said. These, combined with ultra-modern styling, make the new series one of the most outstanding in the history of the company. Console, table and farm models are included in the new series.

Sonora 3-Way Portable

An outstanding versatile 3-Way de luxe portable is announced by *Sonora Radio &*

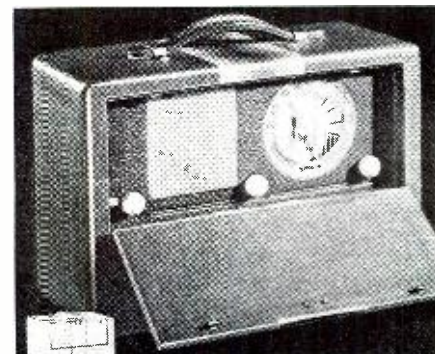

Television Corp. of Chicago. This new portable instrument is a 5-tube Superhet model which operates from self-contained batteries, from 110 volts AC, or from 110 volts DC. Tunes 535-1720 KC. Has the built-in "Sonorascope" loop which eliminates need for aerial and ground; AVC; 5" Dyna-

mic Sneaker; large Speedometer-type Dial; on-off-Battery-AC-DC indicator. Compactly housed in a streamlined portable case covered in brown striped airplane-luggage cloth. Has a sturdy carrying handle and a hinged protective lid. Size: 14" long, 9½" high, 6" deep. Weighs 12 lbs.

1942 Motorola Home Radios

Among the items now manufactured by Galvin Mfg. Co. will be the Motorola Automatic Wireless Record Changer with an improved, smoother-working, patented record changer. This is the unit which proved such a tremendous hit and sold in such large quantities when it first came out. Another new item in the line to be featured will be a combination radio and automatic phonograph in which the phonograph is in a pull out 'Roll-A-Way' Drawer. This Drawer pulls in and out of the console chassis at the merest touch due to its "Feather Touch" Ball Bearing Gliders.



The Self-Tuning Motorola, a completely exclusive unit incorporating "Radio's most convenient feature," will also be nationally advertised. This set contains a patented electric clock mechanism, which pre-selects your programs at 15 minute intervals and tunes them in all day long with no further attention on your part.

The entire line of 1942 Motorolas has been greatly augmented with many unusual and outstanding consoles, combinations, table models, personal and large portable radios.

Metal Shielded Wire

A development of major importance to engineers, designers and manufacturers of electronic and radio equipment is Metal Shielded Wire which is manufactured by

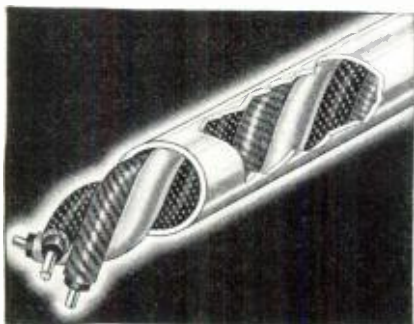

Precision Tube Company, 3824-26-28 Terrace St., Philadelphia, Penna.

This new product consists of shielding any type of insulated wire or wires with either
(Continued on page 54)

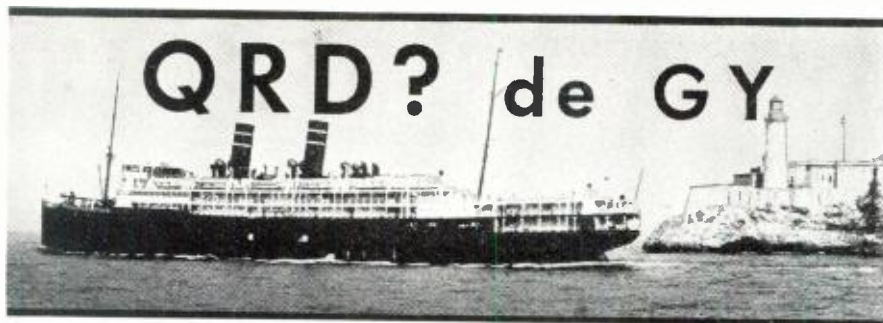

by JERRY COLBY

IF any of youse guys had an idea that the VWOA (*Veteran Wireless Operators Association*) was just a breeze-shootin', reminiscing gathering of old fossils who never did more than hand out parchment scrolls of honor to worthy radiops, the following cablegram dispatched to Premier Winston Churchill proves otherwise: [Quote] VWOA of the United States are proclaiming June 21st as Underground Radio Collection Day for the purpose of gathering radio parts to be sent to England and then gotten into Germany at discretion of British Intelligence so as to keep German Underground radio in operation. This is a cause to which all radio men can dedicate themselves in your fight for freedom. Please cable collect as to manner in which British Government wishes this material sent and to whom. [Unquote.] Transportation of the parts to England will take place after word is received from Churchill or Halifax as to their disposition and likewise after sufficient parts have been received. Hal Styles, President of the VWOA, has asked us to convey this message to you-all so that if there are any spare parts kicking around and for which you have no further use, please shoot them in to your nearest VWOA office. For America's sake we must keep the anti-Nazi German underground communication system operating!

THE *North American Aviation* strike in California set the spark to an already overloaded dynamite keg and ignited the whole country against the subversive activity that has been going on thru the machinations of groups in some of the CIO-affiliated unions, and with special emphasis on marine, radio and aviation unions. Why these unions have permitted the infiltration of these groups is a moot question but the fact that they have been permitted to operate, to foist themselves on the gullible membership to noisily control and direct every organization activity is something only Communists, Nazis and psychologists can correctly answer. If we may be permitted an opinion it is our guess that the average American is an easy-going sort of guy who sits in at an occasional meeting of his union without taking part in any of the discussions that may arise. He won't fight for any office but, on the contrary, tries to get George to do the work. He pays his dues and although he is part and parcel of the whole organization, he would never think of demanding an accounting of the money paid in. All of which is the reason why, we believe, that small groups who have a set program, a goal to aim at, can do what they will regardless of the size of their organization. American Radiops: *Don't fear your officials!* Remember that the man who is secretary of your local and who hands out the jobs was put there by you. If he shows discrimination, favoritism or any other traits which are not in keeping with his job, throw him out of office. You are paying his salary; don't forget this! And above all remember that there are more loyal Americans in your individual local than there are subversives. Throw them out for your sake, for my sake and for America's sake.

WE note with pleasure that Brother Karl Baarslag, General Chairman of the *Radio Officers' Union*, radiop and author, is going through a course of training at Annapolis after which he is slated to be transferred to the Atlantic Battlefleet. How that

big bruiser hasn't flat feet with all that 6'6" weight pressing down on his arches goes to prove you can't tell what's on the deck from the end of a yardarm. We certainly wish Karl the very best of luck and hope that smooth sailing and clear skies will be his'n on whatever ship he sails.

SEZ Brother Edgar Quick from way down in the Caribbean: [Quote.] There is quite a bit of weepin' es wailin' es gnashin' of the old tusks just now in Unifruit Co.'s "Great White Fleet." With ships frequently changing skeds, some going over to the "monkey flags" and others to the Navy, the boys want to know "Whatinell's going on?" Last week two of our blue-ribbon mail ships, the *SS Quirigua* and *SS Chiriqui* were suddenly commandeered by Uncle Sammy's Navy. [Unquote.] Incidentally, Quick had, to be darn fast to get off'n the *Quirigua* on which he had been 2nd opr when the vessel was taken over. Fortunately he was transferred to the *Jamaica*, so no time was lost. Good luck, OM.

THE International watch wave of pre-blitz days ain't wot it uster wuz! Gone are the erratic keys of the Spaggetti-twisters and silenced are the radio operating Jerry 3rd mates; rarely ever are our cars greeted with that Marconi swing of his Majesty's mercantile marine and gone are the grumbling Grecian sparks. Vanished, too, the Frenchies, and only on very special occasions will one hear a Netherlander emit a furtive peep; the sons of the Rising Sun seem to have piped down on their Kata-Kana fat-chewing, and the reception of a Scandahoovian on the air is almost worth a Red ink entry these days. And, while there is no dearth of Yankee signals, the American Bug-tickers are confining their chatter to matters of business! Their loquacious ardor having been dampened by FCC decrees. But the war has produced some new and mighty strange bed-fellows of the Sea. We are hearing an odd collection of signals from Spaniards, Uruguayans, Peruvians, Icelanders, Venezuelanders, Portuguese, Hungarians, Yugoslavs, a conglomeration of Central Americanos and, so'elpus, if WSL wasn't calling a ship the other day whose call letters indicated he was of Saudi-Arabian registry! Live and learn. No doubt an intrepid Arab Dhow spreading his colorful lateen sails in the Atlantic Breeze in order to cash in on the increased freight rates, or, perhaps, a radio equipped "ship of the desert." Quien sabe?

FROM the Great Lakes area Charley Bolvin broadcasts: After much fussing and fuming on the part of *Pan-Am Airlines*, American Export received an \$800,000 government subsidy, so there is another place to go hunting for a job—if and when a feller needs one. If the durn war ever ends, American Ex may turn out to be a big-time air outfit with all the shipping interests involved. Also in the airlines dept. is word from Mid-Continent that they are now signed A.I.C.E.A and are after a \$165 minimum (which ain't hay). *Braniff* radiops received a \$25 increase in their minimum after signing with them. MCA is also asking for at least ten dollars extra for the Chief's berth at each station which will approach a white man's wages. Also from MCA comes info that
(Continued on page 57)

THE NEW IRC VOLUME CONTROL MANUAL IS HERE!

(3rd Edition)



35% MORE LISTINGS—MORE ACCURATE—EASIER TO USE

- ★ The finest, most complete manual of its kind ever published. Unexcelled in its helpfulness to every serviceman who makes control replacements.
- ★ Lists correct controls for over one-third more radio receiver models than ever before.
- ★ Every replacement recommendation checked and double-checked against manufacturers' drawings, revised specifications or latest engineering data, etc.
- ★ Gives everything you need to know about a control *at a glance*—from manufacturers' original part number to Rider's

Manual reference, price, switch data, etc.

- ★ Trade and brand names listed *alphabetically* so that you can find them quickly.
- ★ Auto radios listed the logical, easy-to-find way—by make of car.

- ★ New, large 8½" x 11" size with 136 pages and many new features including a handy information section, charts and formulas and complete IRC Control and Resistor catalogs.

- ★ The latest, most up-to-the-minute Manual of its kind on the market—now available through IRC Volume Control Jobbers.

Don't Miss It . . . Get Your Copy Today!

STANDARDIZE ON TYPE D CONTROLS . . . IT PAYS!

Except for the necessary "specials", etc., this new IRC Manual is based entirely on the use of Type D Controls with Tap-in Shafts—IRC's famous small-size "Universal" Controls that have been breaking one sales record after another for more than two years. They are fully dependable—easier to install—more efficient. Tap-in Shafts frequently avoid the use of more costly "specials"—and a small, inexpensive control stock equips you for the big majority of all jobs.

"Streamline" your work by using Type D's.

18 Controls, 6 Switches, 5 Special Extra Shafts—to handle 60% to 75% of your control needs—all included in the attractive IRC Metal Cabinet for only \$14.97 net, \$24.95 list.



INTERNATIONAL RESISTANCE CO.

401 N. Broad Street • Philadelphia, Pa.

the Dependability of
OHMITE PARTS
 counts more than
 ever now...

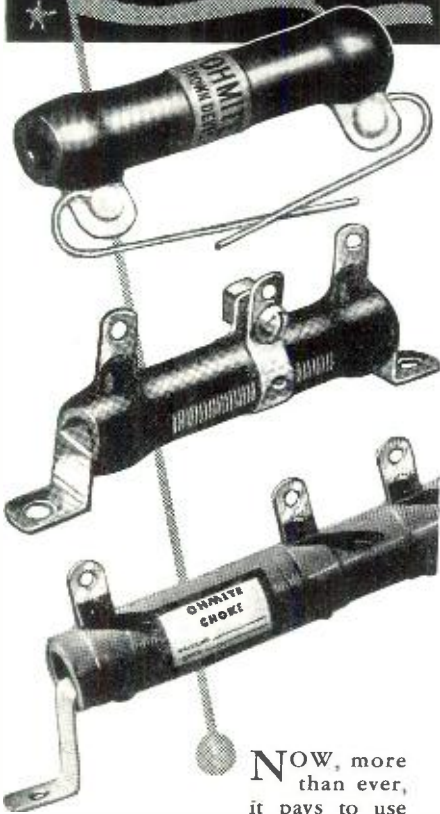

NOW, more than ever, it pays to use Ohmite Parts, because you can depend on them to give trouble-free service and prevent costly breakdowns. Ohmite Brown Devils are available in convenient 10 and 20 watt sizes, in many stock resistance values. Ohmite Dividohm Adjustable Resistors are handier than ever for quick replacements or change of resistance values. Sizes from 10 watts to 200 watts. Ohmite Power Line Chokes prevent R.F. current from interfering with radio receivers. Get them at your Jobber.



Send Coupon and 10¢ for New Ohmite Ohm's Law Calculator

OHMITE MANUFACTURING CO.,
 4885 Flournoy St., Chicago, Ill.

10c in Coin enclosed. Send Ohm's Law Calculator.
 NAME
 ADDRESS
 CITY STATE.....
 OCCUPATION.....
 Radio News-Sept. '41



MANUFACTURER'S LITERATURE

Our readers are asked to write directly to the manufacturer for this literature. By mentioning RADIO NEWS and the issue and page, we are sure the reader will get fine service. Enclose the proper sum requested when it is indicated.

Sonora Radio Brochure

The new line of *Sonora* radios and phonographs is profusely illustrated in a new brochure now available. It is entitled "Listen America!" and features the new Clipper Series, the All-American Model LMS-178. These radios feature the latest improvements and are engineered to a high standard of quality. New cabinet designs are in keeping with trends of modern-day home furnishings.

The new three-way "candid" by the originators of the "Personal" portable are introduced. These sets operate not only from self-contained batteries but from AC or DC electric outlets as well. There are three new models to choose from: Model LP-161, a striking plastic model of luxurious grey-black, with hinged door; Model LP-162, "Jewel Box" model of solid walnut, with hinged lid; Model LP-163, a deluxe version in genuine top-grain cowhide leather in rich Florida tan finish. Each of these receivers has built-in "Sonorascope" loop and no aerial or ground is required. Further information on these units and on many others in the *Sonora* line may be had by writing for "Listen America" to *Sonora Radio & Television Corp.*, Chicago, Illinois

Miller Catalog No. 42

Readers will be interested in the new *Miller* General Catalog No. 42, which is now off the press. Among the items illustrated and described are a complete line of replacement coils, line filters, line filter chokes, tie points, fibre grommets, eyelets, industrial coils, diathermy chokes, I. F. transformers and trimmers, R. F. chokes, coil kits, and special R. F. windings. The *J. W. Miller Company* has long specialized in the design of special types of coils for application in radio and allied industries. They have pioneered in the design of various types of radio interference filters for electric signs, traffic signals, converters, motor-generators, electronic test booths, etc. and for marine applications. A very complete line of kits is illustrated and described, and several pages describe various types of complete kit assemblies for the construction of receivers, high fidelity tuners, aircraft and auto sets, all-wave tuners, etc. A complete line of replacement parts for many radio receivers is listed. Copies of this catalog may be had from the *J. W. Miller Co.*, 5917 South Main Street, Los Angeles, California, upon request.

Simplified Sound Systems

Here is the latest sound catalog published by *Montgomery Ward & Co.* which features a complete line of P. A. equipment and accessories. Material is presented in such a way that the selection of a sound system presents no more difficulty to the layman than when purchasing a radio receiver. Of particular interest is the new *Airline* All-Purpose Portable Sound System, which is offered in four different combinations of phonograph and speakers in carrying case. The units are so arranged that they may be packed into a very compact portable assembly and set up for operation in a short period of time. One such unit features a 25 watt amplifier and one dynamic speaker in case.

Another features the same equipment with two speakers mounted within one case. A wide choice of microphones gives added appeal inasmuch as the purchaser may select the one best suited for his purpose. The deluxe line of *Airline* Amplifiers includes many new technical features, and the controls are arranged to permit full vision to the operator.

New battery or electrically operated sound systems are also listed. These may be used anywhere, and are designed for maximum flexibility. The new "professional" sound equipment will serve any school or institutional installation. This line includes the popular custom-built sound equipment, which is mounted in a handsome rack and panel cabinet and includes units which are designed for specific purposes. Among the other new items are the new *Airline* theater sound amplifiers, church sound systems, and new accessories.

A complete listing is given for the *Airline* chime records. These have been especially recorded to be used in conjunction with high fidelity equipment and will reproduce as well as the best records available. 116 selections are available. Copies of this new catalog may be obtained by writing to *Montgomery Ward & Company*, Chicago, Illinois.

Staco Relay Catalog

The new *Staco* catalog No. 641 is now available upon request to the *Standard Electrical Products Company*, Minneapolis, Minnesota, U. S. A. A very complete line of relays for all applications is listed. Among them are those designed for break-in operation, R. F. relays, change-over relays, communications relays, time-delay, mercury switch, keying, power, and several types of miniature relays. Listed also is a selection of *Staco* sensitive relays, specially designed for use in electronic and delicate control applications, such as burglar alarm systems. Adjustable over-load relays are available in various current ratings. The operation of these is such as when the current passes the point for which the relay is set, the $\frac{3}{16}$ inch silver contact opens the plate supply circuit until the relay is reset and the overload condition removed. Special latching relays are available and these are employed where it is not desirable to have current continuously on the coil. They are available in several models. Requests for copies should be made direct to the manufacturer listed above.

RCA Tube Chart

This new chart, which now covers 309 types of receiving tubes, retains the convenient booklet form of the preceding edition. Included is data on all *RCA* glass and metal receiving types arranged in numerical-alphabetical order.

The first two pages show a classification of the types according to their cathode voltages and their functions. Types having similar electrical characteristics are grouped in parentheses. This classification will assist the tube user in identifying type numbers and in choosing a tube type for an application. The last two pages show socket connections with *RMA* designations (4AD, 4B,

(Continued on page 48)

Ultra Modern Xmtr.
(Continued from page 12)

Speech Amplifier—Modulator Unit

The following tube line-up is used in a speech amplifier-modulator: 6SJ7 pre-amplifier; 6C5 second audio; 6L6 driver; and push-pull 811's for the modulators. A 6SJ7 peak limiter is provided to improve the modulating characteristics of the transmitter. A consistently higher level of modulation is possible by eliminating the unwanted peaks from the modulator unit. The chassis for this unit may be seen, third from the top, and includes all of the components required, with the exception of the power supply. Jacks are provided on the rear edge of the chassis for microphone and push-to-talk mike control. Also included is a toggle switch which is used to transfer from fone to c.w. operation. Connections to the meter and to other circuits is made by means of a multi plug-in connector which may be seen in the illustration.

The high voltage leads are brought into the chassis at the right-hand side through ceramic feed-through insulators. Other features of the speech amplifier modulator unit are self-evident by reference to the schematic diagram.

High Voltage Power Supply

A heavy duty power supply is employed and all filter condensers and resistors have been designed for ample safety-factor in order to guarantee consistent and trouble-free operation. This unit is placed in the lower compartment of the cabinet. Control terminals are provided on the chassis for a key and for stand-by connections. Fuse receptacles are so placed that, if necessary, the fuses may be replaced by the operator at this position.

Safety features have not been overlooked in the design of this unit. Plate power is removed whenever the rear door is opened by means of an interlock door switch which may be seen mounted to the spare-tube shelf. Note the complete set of spare tubes mounted on the shelf within the cabinet. This is a most convenient arrangement and one which will appeal to every operator. Of course, all spare tubes should be tested in the transmitter before they are stored. This will guarantee continued performance when a new tube is required at any point in the circuit. They are well protected from damage when kept in this manner.

Tuning

It is only necessary to resonate the final amplifier tuning condenser when changing frequency within a given

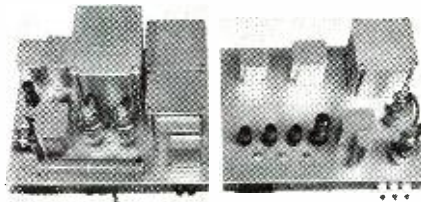

High voltage supply & modulator units.

band. Adjustment of the modulating level may be had by means of the control placed on the small square panel seen in the center of the speech amplifier modulator section. Other controls are the on-off switch for filament power, with its associated pilot light indicator and another for applying plate power, also including another indicator lamp.

The entire transmitter is included in a cabinet which measures 67 3/4" high x 18" deep x 22" wide. The cabinet is equipped with a hinged rear door protected with safety interlocks that automatically disconnect all high volt-

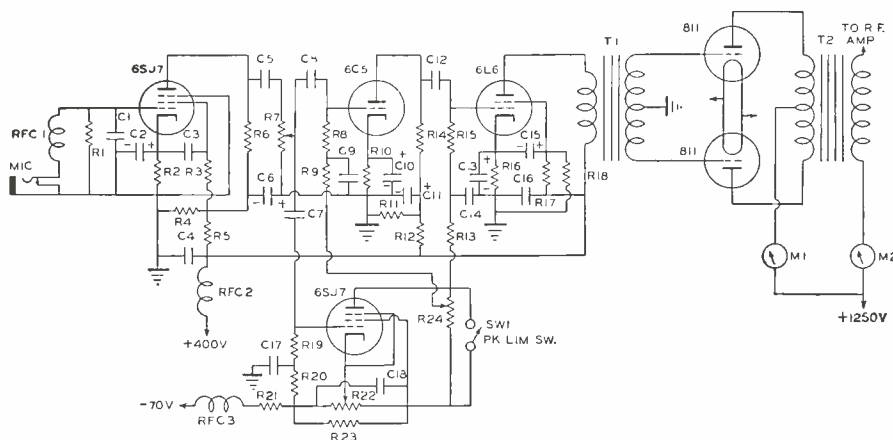

- C₁—0.001 mfd. mica, C.D.
- C₂, C₁₀, C₁₃—10 mfd., 25 v. electro, C.D.
- C₃, C₉, C₁₄, C₁₇—1 mfd., 400 v. paper, C.D.
- C₄, C₁₈—0.02 mfd. mica, C.D.
- C₅, C₈, C₁₂—0.5 mfd., 400 v. paper, C.D.
- C₆, C₁₁—8 mfd., 400 v. electro C.D.
- C₁₅, C₁₆—8 mfd., 400 v. electro C.D.
- C₇—0.1 mfd., 400 v. paper, C.D.
- R₁—3 meg., 1/2 w., Erie
- R₂, R₁₀—2000 ohms, 1/2 w., Erie
- R₃—1 meg., 1/2 w., Erie
- R₄, R₁₁, R₁₃—75,000 ohms, 2 w., Erie
- R₅, R₁₂—10,000 ohms, 1/2 w., Erie
- R₆—250,000 ohms, 1/2 w., Erie

- R₇—500,000 ohms pot., Centralab
- R₈, R₉, R₁₄, R₁₅, R₂₀—100,000 ohms, 1/2 w., Erie
- R₁₃, R₁₆—500,000 ohms, 1/2 w., Erie
- R₁₀—250 ohms, 10 w., Ward-Leonard
- R₁₇—25,000 ohms, 3 w., Erie
- R₂₁, R₂₂—5,000 ohms, 2 w., Erie
- R₂₃—10,000 ohms, pot., Mallory
- R₂₄—50,000 ohms pot., Mallory
- T₁—Driver transformer, Kenyon T253
- T₂—Modulation Transformer, Kenyon T461
- M₁—0-300 Ma. meter, Triplett 227 A
- M₂—0-500 MA meter, Triplett 227 A
- RFC₁, RFC₂, RFC₃—RF chokes, Johnson
- SW₁—SPST Toggle H & H

**DEALERS
SERVICEMEN
AMATEURS
BUILDERS
P. A. MEN**

NEW

**FREE!
RADIO'S
GREATEST
CATALOG!**

212 PAGES • BIGGEST YET!

**SAVES YOU MONEY
ON EVERYTHING IN RADIO**

**50 NEW
KNIGHT
1942 RADIOS**

See the new KNIGHTS for 1942—the greatest radio line in years! New Personal 3-way Portables; latest P.M.-AM models; World-wide receivers; new Plastic sets; Recorders; Phono-Radios; Auto Sets; Farm Radios. There's a model for every requirement—and the prices are amazingly low! Get this 212-page 1942 Catalog!

**SAVE ON
EVERYTHING IN RADIO**

NEW SOUND SYSTEMS

PA at its finest—systems for every application—7 to 60 watts. Exclusive new features—easy Time Payment Plan—15 Day Trial Offer.

AMATEUR GEAR

All the new Communications sets—new x-mitters—new tubes and specialized Radio equipment.

15,000 RADIO ITEMS

Complete stocks of parts, tools, test equipment, books, tubes, etc. Over 15,000 radio items—all at lowest prices!

BUILDERS' KITS

Builders need this 1942 book! New kits, diagrams, supplies—everything in radio for the builder. We'll supply parts lists for any circuit described in magazine radio construction articles.

Radio Builders Handbook

Gives all the dope on building; easy to understand; illustrated. Only... **10c**

Radio Dictionary

Completely defines commonly used radio terms. Only... **10c**

ALLIED RADIO

833 W. Jackson Blvd., Dept. 1-J-1, Chicago, Illinois.

Send your FREE 1942 Radio Catalog.

Find 10c enclosed for "Builders' Handbook."

Find 10c enclosed for "Radio Dictionary."

NAME

ADDRESS

CITY..... STATE.....

ages when the door is opened. The power output of the transmitter is 250 watts, conservative, on radiotelephone and telegraph. The frequency range includes from 1750 kc. to 30,000 kcs. Other ranges are also available and special coils may be wound to cover these other frequencies according to the needs of the individual builder. Four individual chassis are employed when the transmitter is built for radiotelephone and telegraph operation. If the telephone feature is not required, only three units will be needed. All inter-connecting wires are of the plug-in variety with the exception of the high voltage leads, which are connected to the individual units through high-grade feed-through insulators.

Wiring is done by means of high voltage cabling, and this is carefully bonded together to prevent vibration. This, of course, does not apply to r.f. wiring, which is done with solid bus. The bottom illustrations show how this wiring has been done by the manufacturer. Note the neatness, not only in mounting the parts, but in placing the various wires. It certainly would be a pleasure and a source of satisfaction if every constructor took the necessary pains to achieve such perfection.

—30—

Washington Communication (Continued from page 16)

of radio networks, which could function if telephone and telegraph were inadequate or disrupted. Into this super-net would be tied all transmitting equipment in the country. The DCB recently appointed committees to strengthen and integrate police and fire radio systems in various cities.

The next step will be to organize tight ham nets, which could aid in air raid warning and in disasters which might follow military action. Ultimately, it is hoped to link all radio into the greatest net the world has ever seen.

The 30 Meter Shuffle

AT THIS point, the hams are doing a little pouting and feeling that they have been pushed around a bit by Uncle Sam. Under recent actions of the FCC, the hams have made a few gains—but on the whole, they lost ground under the new orders. They can take consolation in the realization that it is not as bad as it might have been—nor as bad as some have urged. Here is a summary of recent rules affecting amateurs:

In order to facilitate monitoring, the FCC requires that ham stations, must state their own call letters and the call letters of the receiving station at the beginning and end of their transmissions, and if the communications are lengthy the call signals of the two stations must be repeated every ten minutes.

An additional 400 kilocycles for radiotelephone communication and 50 additional kilocycles for frequency modulation have been allocated—both drawn from existing ham bands and not meaning any additional room. The radiotelephone band is now 28,100 to 30,000 kc. and the FM band is from 29,250 to 30,000 kc.

But the blow that killed father was the slicing off of the 300 ham kilocycles from 3650 to 3950. This band will be used by the thousands of Army flyers who are under training now. For months, the Army has been operating under conditions which were less than perfect, due to the crowded condition of the spectrum. Army officers had their eyes fixed on the ham bands and for some time, officials have been resisting pressure to tear into the ham territory. It became inevitable, however, as the *Air Forces* began to expand. On September 1, the hams are to surrender the first part of the band—that between 3800 to 3900 kc.—and the rest of the changes will be made by gradual steps by next March. It is hoped that this will be the only incursion necessary into the ham bands—but there aren't any guarantees with that.

It should be made clear at this point that this move does not represent a punitive or restrictive measure against the amateurs. It was just a case of necessity. The Government had to make a choice between the flyers and the hams—and the flyers were more important. The hams stand ace-high with the powers that be in Washington. This is apparent in all quarters.

During the emergency, both the Army and Navy, as well as the civilian services connected with defense, have had reason to realize what the hams stand for. Lieut. Comdr. John L. Reinartz, who has handled the job of organizing the hams in the Navy reserve system for active duty, paid a special tribute to them in a recent talk.

"There is adequate reason why the amateur should have played such an important part in the development of radio communication," he said. "The word 'amateur' supplies the keynote. Its base is, to work for the love of working. A great body of people with intelligence above the average, working together in one great art with no thought of financial compensation cannot help but advance the art of radio communication.

"Based on this extraordinary spirit of fellowship and altruism, bolstered by the aid of high intelligence, supported without financial gain to themselves or their associates, amateur radio has traced a story that cannot be compared with any other in history. It has no analogy; nor can we find any synonymous class or group in contemporaneous or past civilizations. . . . It is as American as America and it could have been done only in America."

That praise from a Navy officer pretty well expresses the feeling in Washington toward the hams. The fears that many had at the start of the shooting that restrictive steps would be taken have pretty well vanished. The hams have proven their value and unless something unforeseen comes along, their present place is safe.

THE Army Amateur system's ZCB (intercommunication) contest of June 2 was so successful that plans have been made to repeat it on September 8. Members of the ARRS will compete to see who can contact the most stations for an exchange of messages in the prescribed Army form. Points go for the largest number of contacts, number of states, territories and corps areas reached. The general call ZCAA is used and on September 8 the competition will last from 5 p.m. to 3 a.m. local standard time. All hams are invited to listen in.

In the June competition, 807 members of the ARRS participated. Top individual honors went to O. H. Baker, W9UBQ, 1824 Barker Avenue, Lawrence, Kansas, who scored 495,900 points. He worked 95 stations in all nine Army Corps Areas, reaching 29 states and Alaska. John Reed, W6IOJ, 7521 Lankersham Boulevard, No. Hollywood, Calif., was second, with 414,000 points. He had 104 contacts with eight corps areas, 25 states and Alaska. In third place was Guy H. McClaine, W9CEB, Hayward, Wis. He scored 338,256 points, working 70 stations in nine corps areas, reaching 28 states and Alaska.

In the competition between Corps areas, the Ninth (comprising states of Washington, Oregon, California, Montana, Nevada, Idaho and the territory of Alaska) scored first with a total of 3,177,064 points, based on a 72.4 per cent participation factor of its 359 members. The Second Corps Area (New York, New Jersey and Delaware) was second with

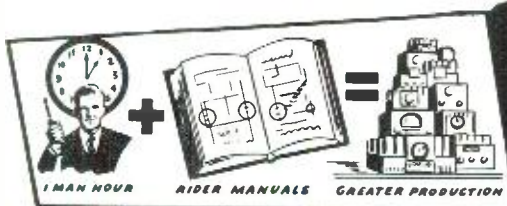

RIDER MANUALS GIVE YOU Greater Production per Man Hour!

The scarcity of good servicemen, the increased use of radio receivers, and the curtailment of new set manufacturing have created a volume of business for service shops that is taxing their capacity. If you are going to turn out your work fast enough to cash-in on the great volume of business that is available, you must have complete servicing data to speed up your trouble-shooting. Rider Manuals can give it to you. This is the only one source where you will find, all in one place, all the authorized information on i-f

peaks, operating voltages, alignment frequencies, parts values, voltage ratings of condensers, wattage ratings of resistors, coil resistance data, dial cable adjustments, etc., etc.—on sets issued between 1920 and 1941. Eliminate guesswork—reduce trouble-shooting time to a minimum—get all twelve Rider Manuals—Today—when you can afford and profit most from them.

Volumes XII to VII..... \$10.00 each
Volumes VI to I..... 7.50 each

OTHER RIDER TIME-SAVING BOOKS

Servicing by Signal Tracing. 360 pages. 188 ill. \$2.00
Frequency Modulation. 136 pages. 76 ill. \$1.00

Oscillator at Work. 256 pages. 167 ill. \$1.50
Meter at Work. 152 pages. 138 ill. \$1.25

Aligning Philcos

Vol. II
Just Out
Over 200 pages
\$1.60

Covers Philco sets from 1937 to 1941, inclusive. Includes remote control and latest loop sets. Order Today!



JOHN F. RIDER Publisher, Inc., 404 Fourth Avenue, New York City
Export Division: Rocke-International Elec. Corp. 100 Varick St., New York City.
Cable: ARLAB

1,375,649 points and the Sixth Corps area (Michigan, Illinois, Wisconsin) was third.

The following is a summary of the results: Corps Area Competition, first place Ninth C.A., with 260 participating for a score of 3,177,064; second place, Second C.A., with 89 participating for a score of 1,375,649; third place, Sixth C.A., with 124 participating for a score of 1,355,216; fourth place, Third C.A., with 69 participating for a score of 1,177,896; fifth place Seventh C.A., with 88 participating for a score of 896,948; sixth place, Eighth C.A., with 49 participating for a score of 293,013; seventh place, First C.A., with 59 participating for a score of 218,708; eighth place, Fifth Corps Area, with 39 participating for a score of 188,449; ninth place, Fourth C.A., with 30 participating for a score of 54,325.

NOTE: There are openings in the War Department Message Center in Washington for men between the ages of 18 and 30, who can copy code at 25 wpm. and type touch system at 50 wpm. The starting salary is \$1,440 per year and there is opportunity for advancement to \$1,660. Those hired will receive instruction in reading syphon recorded tape. For information, write to the Message Center.

WHEN the trial of those Nazi spies arrested by the F. B. I. opens, the country will get its first chance to witness the efficiency of the Defense Operations Section of the FCC. The spies were attempting to clear their alleged information through a secret radio transmitter, which was seized in the F. B. I. raid.

The FCC air detectives had their ears glued to this transmitter and when the testimony on this score is introduced, it will prove sensational.

A COMPROMISE is being worked out secretly between the FCC and the chain broadcasters on the order issued by the Government agency to break up the big broadcasting companies' "monopoly."

Secretly, the broadcasters were not as stunned by the FCC report as they let on in public. They were fearing worse than they got. They admitted as much to Chairman Fly at secret sessions they held with him after Congress had refused to come to their rescue.

On the basis of this admission, Chairman Fly began to soften, gave them an extension of time in which to carry out the orders, which mean a drastic change in present methods. Watch for further softening by both parties.

THE year which has just passed has seen the greatest expansion of military radio in the country's history. The Army Signal Corps and the Naval Communications service have been transformed from minor units into huge organizations, which possess much of the best radio equipment in the world and which will shortly be the best equipped communication services this planet has ever seen.

In June, 1940, the capacity for production of military communications equipment was \$750,000 a month. In June, 1941, this capacity for production had been increased to \$21,500,000 a month. That gives an idea of what has happened in a year in the Signal Corps.

One of the most important items of Signal Corps procurement has been aircraft radio. During the past year, \$103,000,000 has been spent on this type of equipment and in 1942, twice this amount will be purchased. Close in importance to aircraft radio is similar equipment for the Armored Forces and the ground troops. The Armored Forces purchased \$5,270,230 worth of radio in 1941, will acquire \$6,825,000 more in the coming fiscal year. Ultimately, this service will be getting radio at a rate of \$3,000,000 a month. During the fiscal year 1942, ground troops will acquire \$3,400,000 worth of radio. That's not hay.

The Navy, while not acquiring radio on such a large scale as the Army, has almost quadrupled its annual expenditures. Normally, the Navy buys \$200,000 worth of radio equipment annually. In the fiscal year which ended July 1, the Navy had purchased almost \$800,000 worth.

Since 1939, the Navy has almost doubled its radio personnel. Radio officers have jumped from 700 in 1939 to 1,350 in 1941, while the number of enlisted radiomen has increased from 4,600 in 1939 to 9,200 in 1941. Most of new radiomen on the Navy are from the reserves—men trained by the Navy as hams. Of the 903 officers on the rolls of Naval Communication Reserve, 653 are on active duty. Of the 7,000 enlisted reserve men, 5,277 are on active duty.

The armed services have indeed had reason to be thankful for the reservoir of trained American radiomen in this emergency.

-30-

Theory of Recording (Continued from page 17)

the coil. Now, if an iron armature is placed within the coil, and a needle attached, this disturbance will actually move the armature, and needle, back-and-forth within the field set up by the poles of the magnet.

This side-to-side motion does the engraving on the walls of the groove. The high notes cause very small engravings, while the low bass notes actually cut deeper into the walls. In other words, the action becomes more violent as the notes become lower. From this explanation we see that we must not give these low notes too much power from the amplifier as to do so would cause the needle to cut right over to the adjacent grooves and

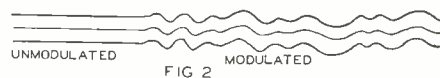

spoil the record. Fig. 2 shows just how these notes appear on the record. The illustration is greatly enlarged for detail. Observe how the grooves take on the appearance of a winding stream as it might appear from high altitudes in an airplane. These grooves appear as straight lines when the needle is at rest—that is—the side-to-side motion stops and the groove is left unmodulated, or free from sound.

To complete the explanation—let us begin at the microphone and follow these sound waves all the way to the cutting needle on the disc. Sound waves are set up by the person speaking into the microphone and actuate the mike in such a manner that these waves set up electrical variations in current which follow the sound waves in cadence. These electrical current variations, although extremely small, pass into an audio amplifier where they are amplified in power to a value high enough to move the cutting needle (stylus) resting on the revolving recording disc.

It stands to reason that if these current variations were weak that the cutting stylus would not receive enough power from the head to drive the needle from side-to-side in the groove. The result would be too much surface noise and not enough sound from the amplifier. On the other hand, if too much power is used, a poor record will result. This will be explained in detail in the series. -30-

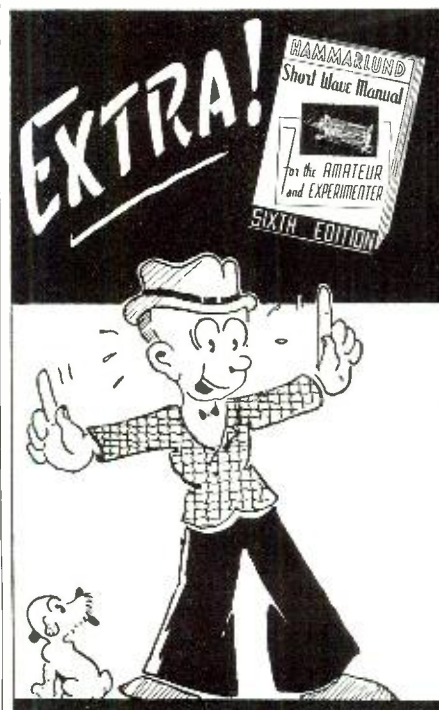

NEW HAMMARLUND SHORT WAVE MANUAL

JUST OFF THE PRESS

TRANSMITTERS
EXCITERS
RECEIVERS
POWER SUPPLIES
ANTENNAS
MODULATORS

EVERYTHING for the Amateur and the Experimenter will be found in this valuable little book. Its 32 pages are crammed with valuable information on constructing and operating short wave transmitting and receiving apparatus. Written in simple language, the new Short Wave Manual will appeal to the beginner and old timer alike. If your dealer doesn't have the new manual in stock, send coupon below, with TEN CENTS to cover mailing and your copy will be sent by return mail.

GET YOUR COPY TODAY!

HAMMARLUND MFG. CO., Inc. RN-9
424 W. 33 St., N. Y. City

Enclosed find \$1.00 to cover mailing costs of manual.

Name

Address

City..... State.....

HAMMARLUND

Canadian Office: 41 West Av. No., Hamilton, Ont.

Portable All-Wave Radio

(Continued from page 22)

"B" are off in the stand-by position.

Construction

The unit is constructed on a 7" x 11" x 2" chassis and mounted in a Bud C994 cabinet. The use of this size chassis requires care in layout to fit all parts in the available space.

Controls from left to right along the lower edge of the panel are, band switch, main tuning knob, pilot light, stand-by switch, phone jack, audio gain, and regeneration control. In the center of the panel, the large knob controls the band-spread tuning. Above this is the power switch.

The first step is to locate a cut out for the "B" batteries, which are mounted in this manner in order to cut down the over-all height. The "A" battery is mounted on top of the chassis by means of a clamp around its base. Referring to the top view of the chassis, a mixer tube can be seen just to the left of the tuning condenser. Along the rear edge of the chassis are mounted, from left to right, the first i.f. transformer 1N5GT i.f. tube, second i.f. transformer, and the 1N5GT regenerative detector. To the rear of the detector tube, is mounted the 25Z6 rectifier tube. The 1A5GT output tube is between the detector tube and the front panel. The output transformer is just to the left of the "A" battery.

In dismantling the *SkyBuddy*, the tuning condenser and band-spread dial were removed from their sub-chassis in order to conserve space. Due to the fact that no connections could be made directly to the chassis, it was necessary to mount the tuning condenser on a piece of bakelite and, in turn, mount this on the chassis.

A panel bushing is used as a shaft bearing for the band-spread dial, which is driven by a cable in the original manner. For appearance's sake, the

main dial is mounted behind the panel and an escutcheon, similar to that used on the band-spread dial, placed over it. The main dial is driven by a friction type drive, mounted by means of fibre washers in order to insulate it from the chassis. The antenna and ground terminals, together with a speaker socket are mounted along the rear drop of the chassis.

In the under-view of the chassis, coils can be seen mounted close to the band-switch with a baffle shield between them. The regular band-switch was discarded and a conventional type used in order to permit mounting the coils in this manner. All filter condensers are mounted along the rear drop of the chassis by means of a clamp made from scrap brass strap. The padding condensers for bands 1 and 2 are mounted close to the oscillator coil behind the stand-by switch. Between the "B" batteries and the front panel, filter chokes can be seen, the larger being the choke for the filament supply. Other parts are placed wherever convenient and as close to the plates used as possible. *It will be necessary to wire in the 1R5 tube before placing the coil switch and coils in position.*

Although the original i.f. worked fairly well, more gain and greater stability were obtained by using the permeability units shown. The transformer, T2, is removed from its can and three turns of No. 22 push-back wire wound around the dowel next to the grid coil. It will be necessary to have the right polarity on this winding if the detector is to oscillate.

Care should be taken to see that no connections are made to the chassis with the exception of the ground terminal and one side of condenser C1. An insulated wire is run from point to point in the circuit to act as the circuit ground. When wiring is completed, a continuity test should be made to make sure there is no connection between the circuit grounds and the chassis.

Alignment

With a pair of phones plugged in the phone jack, the power switch thrown to the "battery" position, and the regeneration control towards the "ground" end, a 455 kc. modulated signal from a test oscillator is applied to the stator plate of condensers C2, C3, and the adjustment screws of the i.f. transformers varied to obtain maximum response. After they have been aligned in this manner, the regeneration control should be advanced to just below the oscillating point, and a slight touchup adjustment made.

If it is impossible to make the detector oscillate, reverse the connections to the tickler. If, still no oscillation is obtained, it will be necessary to add more turns to the tickler winding.

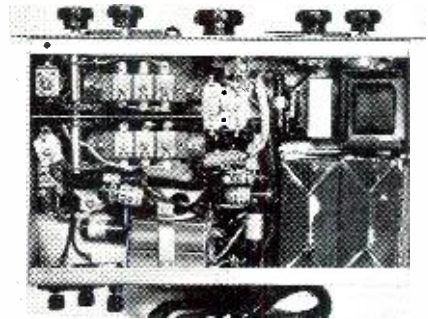

Bottom view shows compact wiring.

The detector should just go into oscillation at the maximum setting of the regeneration control. After the i.f. has been aligned properly, the band switch should be placed on Band 1, the main dial set to 1400 kc. and the band spread condenser set with the plates entirely unmeshed. A 1400 kc. modulated signal should then be applied to the antenna terminals, and the trimmer condensers across both the antenna and oscillator coils adjusted for maximum response. Now, set the main dial to 600 kc. and retune the signal generator to 600 kc.

The series padder on this band should then be tuned for maximum response. Retune to 1400 kc. and make a slight readjustment of the trimmers.

Now, switch to Band 2 and set the main dial and signal generator to 4 mc. Adjust the trimmers to give maximum response at this frequency. Retune to 2 mc. and adjust the series pad and then again trim at 4mc.

Switch to Band 3 and set the main dial and signal generator to 14mc. and adjust the trimmers on this band. Retuning to 7 mc., check the alignment at this point. The series pad on this band is fixed and no adjustment is possible. However, calibration should be fairly close.

On Band 4, the trimming is done at 30 mc. and the band is checked at 18 mc. This completes the alignment of the receiver.

After aligning, the power switch should be thrown to the "line" position and the rectifier allowed to warm up. Operation should be the same as on battery, with the exception of a slight increase in volume and sensitivity due to the higher "B" voltage. If used on dc., it may be necessary to reverse the line plug to obtain correct polarity. The total filament voltage when used on line power should not exceed 6.5 volts and if it is not approximately this figure, it will be necessary to change the value of resistor R8. -30-

Why Thordarson Amplifiers lead the sound field!

Continued research under actual operating conditions has developed circuits capable of outstanding performance no matter how exacting the acoustical requirement. THORDARSON Amplifiers incorporate many distinctive characteristics including: (1) new tone compensation for naturalness and brilliance, (2) conservative ratings, (3) improved design in ventilation for continuous operation, (4) hum level below audibility, (5) Tropex transformers for protection against moisture, salt air, and high humidity, (6) multiple input channels, and (7) maximum flexibility of controls. Remember, Thordarson has a complete line—from 8 to 55 watts output and the pre-amplifier and booster amplifiers for higher power rack installations up to 1,000 watts. Thordarson universal mobile, storage and dry battery amplifiers enable sound specialists everywhere to handle any type of installation. See your Thordarson distributor today and ask for Amplifier Catalog No. 600-F.

THORDARSON

ELECTRIC MANUFACTURING CO.
500 W. HURON ST., CHICAGO, ILL.

TRANSFORMER SPECIALISTS SINCE 1895



by Samuel Kaufman

THE skeptics still can't believe it. But it's true. The guesswork is over. Commercial television is here. But the triple-threat problem of the moment is "when, how and where will sponsored video programs show a profit?"

No one in the industry the Video Reporter has encountered would dare answer that question. Only time will work out the answer, they say. So, while we're biding our time, the television station operators are praying that advertisers will buy their video time.

While the FCC order permitting commercial video operation as of July 1 was applicable to the entire nation, it was in New York that the new art got its most prominent launching.

As anticipated, the RCA-NBC station WNBT (the erstwhile W2XBS) leaped to the fore with the first complete schedule, the first set of sponsors and the first commercial rate card. The CBS and DuMont stations were slower to start, with complaints about materials being held up given as the reason. However, the CBS station, assigned the No. 2 video channel, found itself in the embarrassing situation of not even having a skeleton-sized audience equipped to receive its programs. But with receiver revision in sight (to be done gratis in the case of RCA sets) the Columbia emissions from the top of the Chrysler Building should soon have a batch of lookers-in.

Despite the long experience NBC has had in video program building, the initial week's schedule of commercial operation showed all the faults of the experimental periods. The week's schedule was top-heavy with sports events, thus again implying that the video-equipped bars and taverns are getting consideration over the home look-and-listener.

True, the sports events are excellent television fare. But there must be variety to satisfy the home listener. And by variety we don't exactly mean the vaudeville trade use of the word; rather, we mean that television should embrace, typically, as wide an assortment of entertainment and educational subjects as sound radio does today. There's no reason why it can't. Yes there is, too! But there's only one—and that's economy! It's apparently cheaper to pick up outdoor sports and special news features inasmuch as such programs are reputedly cheaper than studio productions.

We've mentioned this before, and it's annoying to find the domination of sports still in existence at the start of commercial television. Adding the dollar sign to television programs hasn't in the least altered the film program difficulties of the experimental period. Initial film presentation on NBC's commercial schedule was entitled "Death from a Distance" and, titularly, if in no other respects, the selection hardly seemed apropos of the "official" birth of the art of seeing over distance.

CBS promised to start its television schedule the same day as NBC, but complete details were withheld from the press and, despite the fact that program experiments under Gilbert Seldes and Adrian Murphy have



Gilbert Seldes

been going on for some time, it is anticipated that it will take CBS a bit of time to present its full schedule along well-polished and well-finished lines.

Columbia still is adhering to its loyalty to color, despite the fact that its initial service is in black-and-white. The network announced that experiments are continuing on its color video system and that the data collected from these tests will be submitted to the FCC by January 1, 1942 "for consideration relative to the standardization and commercialization of color television."

The DuMont station, according to Will Baltin, television program director, expected a bit of delay past the official July 1 starting date, but was prepared "to go."

No difficulties were reported due to the shift from 441 lines to the commercial 525-line picture standard. Directions were circulated to set-owners whereby they, themselves, could make the simple adjustment by rotating the synchronizing control and, in some instances, the picture-width knob. Also, the shift to frequency-modulation for television sound was not considered a great handicap to set-owners inasmuch as tests showed that early receivers could intelligibly receive the present sound portions of eye-and-ear air shows. This, of course, is not ideal—most look-and-listeners are demanding "perfect" sound and it is believed all sets will be readjusted to F-M by an early date.



Adrian Murphy

TELEVISION auditions galore have been going on in the New York area and the Video Reporter has heard that there is a storm brewing over just what talent the union will have jurisdiction over video performers. Television being an eye-and-ear medium, acting, radio and film unions all feel that they should have outright control. This battle came up long ago when television was in an embryo state. But it seems that actors still look on it as an embryonic art and, while they are anxious to get their foot in the door, they don't anticipate lucrative returns for some time to come. And the one important role the unions believe they can fill is to see that artists are not exploited without being paid.

ALLAN B. DUMONT, head of the television laboratories bearing his name, is vice-president of the recently formed *Majestic Radio & Television Corporation*. Thus, there is an indication that *Majestic* will be active in television set production on a large scale and that *DuMont* is entrenching himself more and more firmly in every branch of the video art, including engineering, telecasting and set manufacturing. *Paramount's* connection with *DuMont* is still a bit enigmatic. Certainly, the tie-up should stand to the television firm's advantage as a supply source for filmed program fare. But, speaking of all movie-video links, it is unlikely that television will get priority over the theatre exhibitor in the choice of films until television can pay its own way (and pay for the films, too).

IT is an acknowledged fact that the first batch of television sponsors are getting more promotional value out of their publicity announcement than out of the programs themselves. Television is honestly and truly a commercial medium. But its coverage is so small that it's not even associated with a big question-mark. Rather, the total receivers in use in the New York area at the time of this writing would be punctuated by an exclamation point! It's admittedly small. But it will undoubtedly grow and grow as programs improve and get the word-of-mouth good-will publicity they don't yet deserve.

Novelty value is not enough to sell television receivers on. And until receivers are sold in volume, television sponsors will be in the novelty classification right along with their offerings. (Continued on page 49)

CONVENIENCE

the NEW Meissner ANALYST

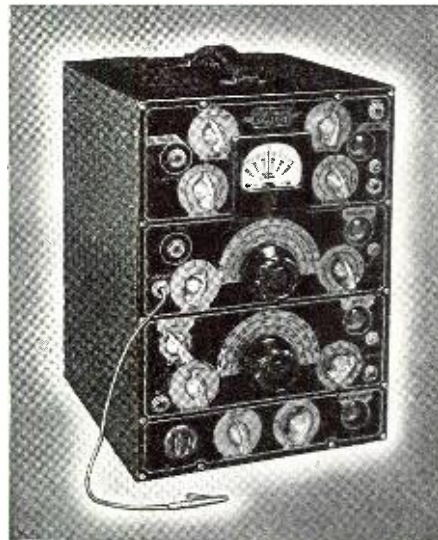

-has it!

The NEW Meissner ANALYST, with Direct Reading Electronic Voltmeter, is designed for the Modern Service Bench. Built for SPEEDY trouble-shooting, its carefully planned convenience will save EXTRA time . . . when time counts! You can get those RUSH jobs out in really short order—and know they're right!

Convenience is built into the ARRANGEMENT of controls on the new panel! Each Channel has its own separate section, plainly marked, and every control is right where you would expect to find it! No groping around the panel (or back of the cabinet) for a switch or jack connection . . . it's right there on the panel . . . where it belongs!

For that matter, ALL controls and jacks are ON THE PANEL! If you want to mount this instrument in your wall rack . . . that's your business . . . you won't have to turn the ANALYST around after it's plugged in!

Complete with tubes . . . ready to operate Model 9-1040 ANALYST, Net . . \$96.25

SEE YOUR JOBBER—TODAY!



NEW INSTRUCTION MANUAL

F-M Data and valuable service information in addition to instructions on all Meissner Kits and equipment; 168 pages!

Only 50c Net

WRITE FOR FREE 48-PAGE CATALOG!

Dept. N-9



W.T. CAR MEL ILLINOIS

"PRECISION-BUILT PRODUCTS"

the Death-Blow to FEEDBACK

New TURNER CARDIOID

Out-Performs Many Mikes
Selling at Twice the Price

THE Answer to the sound man's problems! Two-element generator gives true cardioid characteristics; offers the best features of both the velocity and dynamic—with extra sensitivity to sounds originating in front of the mike, while dead as a door knob in back. Where the going is tough and acoustic conditions practically impossible, a Turner Cardioid will do the job.

101A Standard Cardioid, all impedances. List \$55

101B Deluxe Cardioid, same as 101A, except with 3-position switch. List 65

101C Broadcast Cardioid, same as 101B with range extended to 10,000 cycles. List 70

FREE New Turner Microphone Catalog. Write for Yours.

TURNER PUSH-PULL VIBRATORS
Revolutionizing the industry with 10 engineering advancements. Write today for full information.

THE TURNER CO.
908 17th St. N.E., Cedar Rapids, Iowa



BUT WHAT OF Tomorrow?

"All-out" production to meet today's pyramiding orders does not mean that Triplett has lost sight of the broader requirements of tomorrow. Instead, research and engineering programs actually have been "stepped-up" to assure constant improvements in products and processes; in addition to needed developments in new fields.

Today's demands are important, but the needs of tomorrow cannot be slighted—and are anticipated in never flagging engineering and research developments. You have assurance that in the months and years to come, new Triplett products will serve in expanded fields, where they will merit values and savings for every dollar spent in their purchase.

**THE TRIPLETT ELECTRICAL
INSTRUMENT CO.**
Bluffton, Ohio



Bench Notes (Continued from page 13)

tuned, this tendency to "pull together" is most noticeable, and the addition of the 50-ohm resistor will improve the handling of the receiver considerably. It might be well to remark in passing, that the screen voltage of these tubes should always be less than the oscillator anode voltage—in usual practice the screen voltage ordinarily has a value of about one-half to two-thirds the oscillator anode voltage.

Another detrimental characteristic of converters of this type is the fact that the oscillator frequency may be seriously affected by anode voltage variations, and particularly by changes in the bias voltage of the r.f. section, due to avc action. This makes most receivers unstable for short-wave reception, and in commercial receivers this trouble is minimized by several methods. The simplest methods should be of some interest to the service man, as he may often use them profitably in improving the short-wave operation of receivers brought in for service.

Instability due to variations of the r.f. bias voltage is often eliminated by removing the grid returns of the short-wave coil from the avc line, and connecting to ground instead. This procedure will also increase sensitivity in the short-wave bands to some extent. Variations in the oscillator anode voltage may be considerably reduced by making connection directly at the cathode of the rectifier tube, thus avoiding the fluctuation in voltage caused by varying current through the speaker field or choke. This method is most effective when the inductance employed as a choke has a fairly high resistance of 1000 ohms or more.

It may be necessary to increase the value of the series resistor in the anode circuit to reduced the applied voltage to the recommended value, and it will also be necessary to add sufficient capacity (about 16 mf.) from the anode end of the resistor to ground to provide adequate filtering of the ripple picked up at the rectifier cathode.

In order to overcome the drawbacks encountered in the use of these converters for short wave reception the 6L7 was developed, which does the job admirably, by utilizing two control grids that are independent of each other, and injecting the oscillation voltage from another tube. The use of a separate oscillator tube of course increases circuit costs, and for that reason the 6L7 is seldom used in the lower priced sets that constitute the bulk of radio receiver sales. The 6J8G employs practically the same principle as the 6L7, except that a triode section is included in the same envelope for oscillator service, and the tube may be considered as a 6L7 with built-in oscillator. This tube was little used commercially, and is of little interest to the service man.

The next improvement in converter

tubes was the 6K8, which largely eliminates the disabilities of the preceding types. The design is such that there is practically no undesirable inter-action between the oscillator and signal sections, and the frequency of the oscillator circuit is only negligibly affected by variations in avc voltage or anode voltage supply.

The 6K8 should be of considerable interest to the service man, as in many cases it may be directly substituted for the 6A8, with greatly improved results in short-wave reception. This tube is particularly useful when the customer complains of instability and difficulty in tuning the short-wave bands, as the installation of a 6K8 will often eliminate the trouble entirely.

The 6K8 is of value too, when the receiver can no longer be trimmed to reach 17 or 18 megacycles satisfactorily. Since the input capacity of the 6K8 is considerably less than the 6A8, the substitution of a 6K8 will often permit extension of the receiver's range to 18 megacycles with some trimming capacity to spare. In any case the freedom from inter-locking at this end of the band makes the substitution worth while.

While the 6K8 may be installed without rewiring the socket, since the base connections are the same as for the 6A8, there are a few precautions to be observed when such a change is made. In addition to correction of alignment of the r.f. and oscillator circuits, it will be necessary to re-tune the plate circuit of the i.f. transformer, as the output capacities of the two tubes are not the same.

The recommended anode voltage for the 6K8 is 100, and it is generally, although not always, desirable to increase the value of the series resistor in the voltage supply line, to prevent over-excitation, with resulting spurious oscillations. Generally speaking, if the potential is 150 volts or less at the anode this change is not necessary with oscillator coils ordinarily used. The value of the 6K8 as a high-frequency converter is well indicated by its use in some of the new f.m. sets.

The latest mixer tube (at this writing) is the 6SA7, which is not, as many have assumed, a single-end version of the 6A7. The 6SA7 is a tube of entirely different construction, so designed that no one electrode acts as the oscillator anode or plate. Due to this special design, variations of voltage at the r.f. signal input grid have little effect on oscillator frequency, and the stability of the tube at high frequencies is good enough that this tube is also being employed in f.m. receivers. The advantages of single-ended tubes are obvious, in their elimination of the grid lead and cap, therefore it seems quite likely that the 6SA7 will eventually supersede all other types of mixers for new set construction; that is, until the next new type comes out, which, from past experience, may be any time in the next week or two.

Beginner's 14 w. Amplifier

(Continued from page 34)

No. 3 of the transformer listed here. If you use a transformer of another make, follow the directions included with the transformer.

When the microphone cable is attached, the outside shielded lead is connected to the upper terminal and the inner conductor of the cable is connected to the lower terminal. Do not expose any more of the inner conductor than necessary, because there will be a tendency towards picking up hum. If the amplifier happens to be located in a field of heavy a.c. currents, some hum may be picked up anyway, and it will be necessary to build a small metal cover to fasten over the terminal. This cover must be made to shield completely the inner conductor of the microphone cable as well as the lower terminal on the connection strip. The shield must be grounded to the chassis.

The phonograph pick-up lead is connected to the phono-input in the same way. No hum will be encountered; however, as this input does not have the amplification of the microphone channel. If the pick-up lead consists of two individual conductors instead of the shielded lead, connect them whichever way gives the best results.

These instructions apply also to the radio input. The sound quality of the average radio will be improved considerably, if you use this high fidelity amplifier in place of the audio system now used in the radio. To make the change, disconnect the lead which is soldered to the grid connection of the first audio tube in the radio set. Ground the grid connection so that no sound will get through the audio system of the set. The lead which was unsoldered from the grid connection is brought out to the radio input on the amplifier. This lead should be shielded, and the shield grounded at both the radio and the amplifier. If the radio is an a.c.-d.c. type the shield of the lead should be connected to a .1 mfd., 200 V. condenser, and the condenser connected to the ground terminal of the amplifier.

If you are located near a frequency modulated station, this amplifier, when used with a FM tuner, will make an ideal high fidelity FM receiver.

-30-

Ring the Bell

(Continued from page 30)

have lost only *one* repair job by sticking to our guns. There is no telling how much time we have saved, or how much this policy has added to the cash receipts.

Now, we realize that under certain conditions a repair must be made in the home. A few of these follow:

(1) When a repair or installation of an aerial and ground is necessary, (This is *definitely* one thing which can't be handled very conveniently in the shop!!)

(2) When trouble shooting for man-made interference. So far, we haven't heard of any remote-control interference locators.)

(3) When the customer lives some distance from the shop (such as in our section where the customer may live 20 miles out of town and on a plantation) and the repairs are reasonably quick. Even in this case, we recommend bringing the set to town *if* the repairs are of a major nature. Of course, the serviceman should charge mileage on his car.

One parting shot. Just because, on arrival at the customer's home, you find that the only trouble with the set is a burnt-out tube, a loose wire or some other easily-fixed trouble, don't let that prevent you from picking up the set and bringing it into the shop for inspection and further adjustment. (We, of course, assume that it is a set which is not new and has not been repaired within a reasonable time.) This is not wrong. To fix the one little thing and call it "quits" is the wrong thing to do. Why? We'll tell you why. Because, as you jolly well know, that radio chassis needs its tubes checked, its speaker examined, a touching-up of the alignment, a general dusting out, etc. We are thoroughly convinced that a large number of servicemen repeatedly lose additional tube sales because *they do not check every tube in every set*. In like manner, additional labor charges are lost if the serviceman gives the set a quick "fixing" in the customer's home instead of "pulling" the set and bringing it to the shop.

Do the *whole* job and get the *whole*

labor charge as well as boost your tube sales.

The Value of a Monthly Inventory

HOW much is your stock worth today? Your tools and test equipment? Your other fixtures?

How much were they worth last month? Last year?

What quantities and types of stock do you have?

Unless you have this information, you certainly can *not* tell whether you are progressing or not. You can't tell what is good, fast-moving stock and what is not. You are accumulating a whole galaxy of odds and ends of parts, for which you will soon have no use, and which *could* be returned for credit or used in a radio in the near future.

For instance, let us suppose that you have purchased a replacement volume control which you find that you do not need. If it is in re-sale condition, you can return it at once for credit. If it is not in a re-sale condition, you can take extra care to watch for a set which uses that type volume control and which would benefit by the replacement. That is, you can do these things *if* you take a monthly inventory and, as a result, *you know your stock*.

In taking an inventory, the following things must be listed.

- (1) Quantity.
- (2) Manufacturer's stock number.
- (3) Description of part (condenser, resistor, etc.).
- (4) Value (mfd., ohms, etc.).
- (5) Unit net price (what *one* cost you).
- (6) Total net prices (unit net times quantity).
- (7) Suggested quantity to keep in stock.

It is surprising how many times you will refer to such a list for informa-

"MAN TO MAN TALK-- TO THE RECENT HIGH SCHOOL 'GRAD' "

The young fellow just out of High School finds himself in a unique position today. Employers, for the past six months, have been asking for YOUNG radio technicians—fellows of High School age. Normal expansion in the radio industry, coupled to the needs of the national emergency, have created a serious shortage of radio men. The *young fellow* is being sought by the radio industry!

The High School graduate today is faced with the tempting prospect of high wages in factory and shop; plans of higher education may take a back seat for the immediate attrac-

tion of more "spending money." Such employment cannot lead to desirable permanent positions, however, and the young man who does desire something better would do well at this time to pass by such transitory work.

For those considering Commercial Radio as a career, we urge a careful study of the courses offered at the Dodge Institute. Compare them with any other offered anywhere. Contact our graduates for their opinion; or, best of all, visit our school. We invite comparison!

Our Fall class opens Sept. 29. A postal card brings our catalog.

DODGE'S TELEGRAPH & RADIO INSTITUTE
407 MONROE ST. VALPARAISO, IND.

tion. From it you can calculate your list prices. You can see whether a part is moving slowly or fast, and repurchase accordingly. You can set up minimum stock requirements for one month on each item and, thus, carry only quick-moving items. By checking over your invoices every three months you will have a healthy inventory condition.

You should also keep a list of your tools, test equipment, technical manuals, etc., and their value, because this is necessary for a proper knowledge of your business worth, in the same manner as your Accounts Receivable and your Accounts Payable. If you keep a set of books, and we have been urging all servicemen to do so, this information is most vital. As you check over your list of tools, etc., if you find some item which you no longer use (and it has a re-sale value) by all means try to sell it before its value drops to nothing. If you do not inventory these items, you are likely to shove such a piece of equipment into a dark corner and forget it. Turn such useless (to you) equipment into cash. You can always use the money.

In conclusion, we assure you that a properly kept inventory sheet can be one of your best business assets, insuring you of a minimum of loss-items in your stock and returning to you many times the value of the time you spend each month in working it up. It is another way to "Ring the Bell" toward greater profits by *careful buying* and by *knowing your stock*. —30—

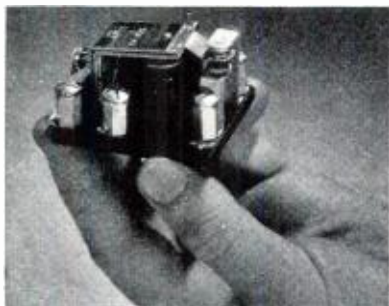

THIS RELAY IS HUSKIER, COSTS LESS

The design of this compact Ward Leonard single pole heavy duty relay is simplicity itself. It is sturdily built yet there is not an ounce of material in it that is not essential to efficient performance. Measures only 1 7/8" x 2 3/8". Will control 3/4 h.p. on 115-230 volts. Described in Circular 507B.

WARD LEONARD RADIO SPECIALTIES

WARD LEONARD ELECTRIC COMPANY
47 South St., Mount Vernon, N. Y.
Send me Circular 507B

Name

Street

City and State

Call Signal

Manufacturers' Literature

(Continued from page 40)

4C, etc.).

Readers can obtain a copy of the Chart 1275-B on request from Commercial Engineering Section, RCA Manufacturing Company, Inc., Harrison, N. J.

"AN" Conduit Fittings

"AN" Conduit Fittings for aircraft rigid and flexible aluminum conduit in accordance with Army-Navy Standards are shown in the September issue of *The Ampheno News*.

Engineers and production men will appreciate the special charts on fitting assemblies which appear on pages 40, 41, 42, 43 and 44, as well as the tables of sizes and dimensions of individual fittings.

Choice of the type of assembly and component parts required is simplified by use of the charts, while the tables permit quick listing of part numbers for ordering and provide a handy reference medium whenever dimensions or clearances are in question.

All of the items listed are available for shipment in most sizes direct from stock. The balance will be in production as soon as tooling now in process is completed.

No price list has been issued at this date. It is suggested, therefore, that bills of material and quantities and delivery dates required be submitted for quotation prior to placement of the actual orders.

The engineers will gladly co-operate with you in solving any problems involving either conduit fitting assemblies or electrical connectors, and in the development of new conduit fittings, or connector inserts, receptacles and plugs. *American Phenolic Corp.*, 1250 W. Van Buren St., Chicago.

—30—

Channel Substitute

(Continued from page 29)

This can be obtained with padders across the condenser, or by removing turns on the oscillator coil, depending on whether the oscillator tank frequency must be increased or decreased.

Since we now have located the 262 kc. point on our dial, by increasing the oscillator condenser, we will lower the available i.f. at the r.f.-i.f. jack, and by decreasing the condenser, we will raise the i.f. The dial can now be calibrated by borrowing a signal tracer or *Channelyst* that has a calibrated i.f. amplifier and plug it into the r.f.-i.f. jack. If these instruments are not available, several BC sets with different intermediate frequencies will serve just as well. The test leads from the r.f.-i.f. jack should be placed at the grid-to-ground of the converter tubes on the receivers. As soon as the signal is tuned in by varying the channel substitute oscillator, the dial should be marked as the i.f. of the set under test.

The antenna is a 1/4-inch rod 16 inches long and threaded with a 1/4 x 20 die at one end. The antenna connector is a piece of 1/4-inch copper stock 1/2 x 3/4". A 1/2 x 20 hole is drilled and tapped at one end, the other end drilled and tapped and fastened to a 1 1/2-inch square piece of bakelite. A 5/8-inch hole is then drilled in the back of the

Par-metal cabinet, with the bakelite mounted inside and the copper bar protruding through. The antenna lead is soldered permanently to this mounting from the inside of the cabinet, the other end terminating in an *Amphenol* plug, which plugs into its receptacle on the chassis.

The top of the *Par-metal* cabinet is fitted with a large door pull which enables the unit to be carried around. The cover is held down by three 10-32 wing bolts. A mounting is inserted under each of these wing bolts from the metal taken from the speaker hole.

The test leads are made up of 3 feet of auto antenna lead-in wire with alligator clips soldered to the shield and the inner conductor. An ordinary phone jack is placed on the other end.

Trouble Shooting

The regular procedure for checking defective sets with the channel substitute would be to tune in the local BC test station and place the test leads in the audio output jack, and across

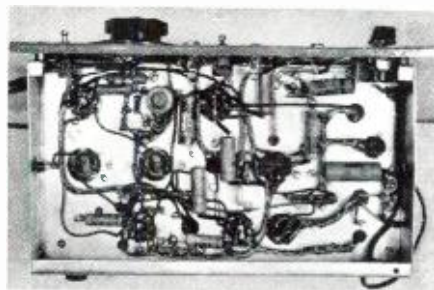

Note neat construction and wiring.

grid to ground of the last audio tube. This will isolate the speaker and output tube from the rest of the receiver. Distortion and output can then be determined in this circuit.

The next step would be to place the same test leads across the diode load, thereby isolating the entire audio system of the defective receiver. Power output, fading distortion, etc., of the audio system can now be checked. Incidentally the voice coil switch on the channel substitute should be placed in the *open position* while making these tests.

If the receiver under test is a super-heterodyne, the test leads would now be placed in the r.f.-i.f. jack. The r.f.-i.f. switch would be placed to the jack position, and the leads placed grid-to-ground on the last i.f. tube. Tuning the oscillator condenser, our broadcast signal will be heard when the proper i.f. beat is obtained, provided there is no defect in the diode detector and its accompanying circuits. If an intermediate i.f. stage is used in the receiver, placing the test leads from grid to ground of this i.f. tube will result in a stronger signal under normal conditions.

The modulator stage is next in line, so with the leads in the same jack we place them again grid to ground, and our broadcast signal should again be heard. This also applies to the r.f. tube and the antenna circuit. If no signal is heard, either the receiver

oscillator or modulator circuit is defective. If the signal is heard throughout the receiver, and not heard when the leads are placed on the r.f. grid to ground or antenna circuit, the trouble will be isolated to this section.

The above operations can be made in a surprisingly short time. However, they should be preceded by checking the tubes. In checking TRF sets, the audio and r.f. checks only are used of course. PA systems may also be checked, stage by stage for distortion, fading, etc. by using the test leads in the audio jack.

Since each channel of a receiver or amplifier is checked individually, using a standard broadcast station as the source of the signal with a minimum amount of effort, the Channel Substitute will greatly benefit the service man. There is no need to measure voltages or currents until the defective circuit is isolated. Intermittents, hum, etc. can be isolated to a particular circuit as easily as an open connection.

When trouble is isolated in diode circuits, the diode input jack of the Channel Substitute may be used to advantage. The leads on the secondary winding of the output i.f. transformer in the defective receiver are opened and the test leads inserted in their places. This test determines whether the trouble lies in the i.f. coil or in the diode circuit.

The entire instrument can be built with spare parts lying around the shop and it will certainly prove its worth on the very first few receivers on which you use it. Try it on some of those "headaches" you have on the bench. After the Channel Substitute has done its work in isolating the trouble for you, it will serve to entertain you with your regular radio programs as you complete the repair work

-30-

3-Band U.H.F. Receiver

(Continued from page 20)

gave excellent performance with no changes. After the 112 megacycle band is working properly, coils for the other bands should be adjusted in the same manner. Coils for the 224 megacycle band will probably require considerable care in adjustment. No difficulty should be experienced with oscillation of the r.f. stage if the receiver has been carefully constructed with proper attention paid to short leads and by-passing.

For occasional listening to F. M. programs, this receiver is quite satisfactory, although it will not give the high fidelity that is a feature of most F. M. transmitters.

Performance of an ultra high frequency receiver depends greatly upon the antenna used and every effort should be made to erect the antenna as high as possible. One of the most satisfactory types for use with this receiver is the single-wire matched impedance type cut to resonate on the

band most used, although quite satisfactory results were experienced with a 4 foot fish pole auto antenna.

COIL TABLE

Band	L ₁ No. turns	Tap	L ₂ No. turns	Taps
43 Mc.	14	2	14	7-12
56 Mc.	10	1	10	5-8
112 Mc.	4	1	4	2-3
224 Mc.	1	1/2	1	1/4-1/2

All Coils wound with #14 tinned wire 3/8 inch inside diameter 1 inch long. Taps are measured from the bottom ends.

-30-

Video Reporter (Continued from page 45)

Just for its potential historical value, we're mentioning NBC's original television rate card which went into effect with the start of commercial service on July 1. It will be interesting to compare it with the television rate card of five years hence.

There are two charges: the first for time on the air, the second for the use of studio, film and mobile unit facilities.

Eye-and-ear program time costs \$120 per evening hour on week-days and half that figure for Monday-through-Saturday daytime hours. Sunday daytime hours cost \$90 each and there are no rates for Sabbath evenings inasmuch as there are no plans at the moment to have programs during that period. The total costs are boosted materially by the tariff of \$150 extra per hour for the use of the main television studio in Radio City. Small and film studios, and field pickups cost \$75 extra per hour.

Time, news and weather announcements are for sale at \$8 per minute at night and \$4 per minute by day.

Notations are made of extra billings for talent, scripts, music, costumes, props, etc.

THERE is little question about the fact that television's commercial debut is accompanied by an almost unconcerned, nonchalant and "come-what-may" demeanor on the part of participants.

Unlike other new radio efforts of the past, there is an absence of showmanship and pep.

Television is coming in like a lamb instead of a lion. It seems sort of scared of its own shadow.

True, there is quite a bit to worry about. With material shortages, a war raging in Europe and the networks in a feud with the FCC, there is a lack of spirit.

There was more enthusiasm on the parts of present participants back in the early experimental days.

Now, it seems that each firm in the field will have to take a sporting chance on gains from the pioneer commercial period calling for big outlays with little—if any—income. But, on the other hand, these very efforts of keeping up with competitors may lead to tremendous receiver sales much sooner than anticipated. If this happens, the initial roster of commercial television station owners will have literal gold mines in the sky.

RADIO retailers were none too quick in trying in with commercial television programs. Reason: no manufacturer was pushing a video line.

And the dealers are cautious due to past experience. They had to bear the brunt of complaints about changed standards, poor models and discontinued program schedules. Further, they had sad experiences and little profit for the big window and floor space they allotted to television in the past. Now, the mere fact that there's a "commercial" label on television doesn't affect them too much. As far as they are concerned, television was commercial in its earliest experimental stages. Any art that calls for salable radio equipment is a commercial art to the dealer.

-30-

WORLD'S GREATEST all around ELECTRIC TOOL

DRILLS—GRINDS—SANDS
SAWS—POLISHES
SHARPENS—CARVES



ONLY
\$7.95
POSTPAID
GUARANTEED
FOR ONE YEAR

The new WHIZ ELECTRIC TOOL is the handiest power tool ever made. A rugged tool for power and precision work. Drills through 1/4 inch iron plate in 42 seconds or engraves intricate designs. Handles any material: Metals—Woods—Alloys—Plastics—Glass—Steel—etc. Saves time. Eliminates labor. Plug into any socket AC or DC, 110 volts. Chuck 1/4 inch capacity. Ball bearing thrust. Powerful, triple-gear motor. STANDARD MODEL, with Normal Speed (uses 200 different accessories, instantly interchangeable). Price only \$7.95.

The only DRILL-TOOL with a full year's guarantee.

FREE Accessory outfit (Value \$2) includes set of drills, mounted 1 1/2 inch grinder, sanding discs, cutting wheels, mounted brush, polishing wheel, carving burr, etc. FREE with each tool ordered NOW. We pay postage.

10 Day Trial—Money Back Guarantee

PARAMOUNT PRODUCTS CO.
DEPT. 9-RN 545 FIFTH AVENUE NEW YORK, N. Y.

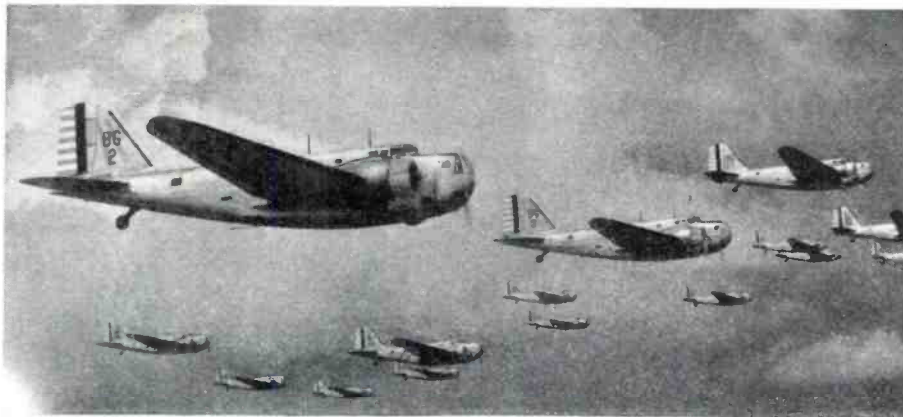

DON'T MISS THE U.S. ARMY AIR FORCES ISSUE!



THIS SPECIAL 284-PAGE ALL-OUT ISSUE ON AMERICAN MILITARY AVIATION IS A "MUST" FOR EVERY RADIO NEWS READER!

- Here is the most informative and comprehensive report on American military aviation and military radio operations ever published! **FLYING AND POPULAR AVIATION'S** Giant September Issue tells the story of the U. S. Army Air Forces clearly and thoroughly . . . including the important role that radio is now playing in military aviation communication and navigation. The complete story—in 27 authoritative and brilliantly illustrated articles—from the first feeble experiments with military airplanes 30 years ago to the huge Army air arm of today . . . detailing and outlining each unit of the Air Forces



- Replete with a special insert of magnificent natural color photographs showing the Army's fighting aircraft in the field and at work, a salon section of fine photography depicting the full range of activities of the Air Forces, two 15"x11 3/4" gate-folds in full color, and a comprehensive account of radio in the Air Forces by Maj. George V. Holloway, this truly inspiring record of American military aviation is a document you will treasure for years to come. Your newsdealer is now featuring this special 284-page all-out September issue of **FLYING AND POPULAR AVIATION**. Get your copy today.



U. S. ARMY AIR FORCES ISSUE

FLYING
AND POPULAR AVIATION

ON SALE AT ALL NEWSSTANDS—50¢

TECHNICAL BOOK & BULLETIN REVIEW

ALIGNING PHILCO RECEIVERS. VOL. 2, BY JOHN F. RIDER, published by *John F. Rider, Inc.*, 404-4th Avenue, New York City, 200 pp., price \$1.60. This second volume of "Aligning Philco Receivers" covers those sets which have been marketed since the publication of Volume 1 in 1937. The tabular form of alignment instructions has been retained, inasmuch as it has been given the enthusiastic approval of the servicing industry. Every effort has been made to correlate closely the instructions and the chassis layouts wherein are shown the location of the various trimmers. Due to the complexity of some of the modern receivers, their adjustments are likewise rather complicated, but even in the extreme cases, the same tabular alignment form has been followed and the extra instructions have been added in the form of comprehensive notes.

The wide-spread use of the loop antenna has necessitated a change in alignment procedure which is explained in the appendix along with a number of other pertinent facts that will be of value to the man who is interested in doing an aligning job as quickly and as efficiently as possible.

"**CYCLOPEDIA OF TELEVISION FACTS**" compiled by M. M. Beitman, published by *Supreme Publications*, 3727 W. 13th Street, Chicago, Illinois, price 40c. Television is today's opportunity field. This new booklet gives the reader a short course in this most interesting phase of radio. The television field in America has been changing so fast that very few books on the subject have been published. To serve as an introduction, and to help you to understand the new terms especially applicable to television, this book has been prepared.

VOLUME XII PERPETUAL TROUBLE SHOOTERS' MANUAL. Just off the press and complete with up-to-the-minute data is the new Volume XII Trouble Shooters' Manual published by *John F. Rider*, 404-4th Avenue, New York City. Included is a complete index for Vols. XI and XII. It is well to state that the information presented in Volume XII is condensed as much as possible in accordance with the requests of owners of previous volumes of this publication, but not at a sacrifice of any material. The attempt to condense the text is based purely upon an effort to include the maximum amount of data. The price is \$10.00.

—50—



"But I don't wanna be interviewed!"

Measurements in Servicing

(Continued from page 16)

and applying the ohmmeter. If the distortion is localized in the 6F5, when such distortion exists, check the cathode resistance if one is used, and the cathode resistance by-pass condenser. If the condenser is open-circuited, the tube's gain or amplification will be reduced, while the distortion of the stage will also be reduced by the same number of decibels. A decibel is the unit of electric power ratio. The least difference in sound intensity that the ear can detect is roughly equivalent to 1 decibel (d.b.).

Oscillation in either the 6F6 or 6F5 stages may be due to feed-back between the grid and plate of the 6F6 or the grid and plate of the 6F5. If the 6F6 has no effective by-pass condenser, such as the .001 mfd. unit connected from the plate to cathode, the plate load, which is an inductive reactance, would force energy to be transferred from plate to grid because of the extremely high impedance or opposition to the flow of alternating current offered by the high inductive reactance at high audio frequencies. The grid-plate capacity becomes less reactive with frequency, while the plate load becomes more reactive, as shown in Fig. 4.

From the equations shown, it is evident that capacitive reactance *decreases* with frequency, while inductive reactance *increases*, so that it becomes easier for the a.c. plate voltage to jump back to the grid than to pass through the plate load inductance. As a result, more and more energy is amplified, until the losses in the grid circuit, due to resistance, are made up. Then, the circuit oscillates or starts to generate power. The effect in the speaker is a howl.

In the case of the 6F5, audio oscillation may be due to a high impedance plate load consisting essentially of resistance. The plate resistor may open up partially, or become very high in value. Or the by-pass condenser, the .25 mfd. unit, may allow vibrations or audio frequencies to get into the 6F5 plate circuit, thence through the grid condenser to the 6F6 grid, which allows oscillation by means of still another route.

If the grid circuit impedance of the 6F5 is high, as it usually is, the grid wire connection must be shielded to prevent hum pickup and oscillation. If the 6F6-G tube is used (glass envelope) and it is placed near the 6F5, the energy in the 6F6-G plate may be fed back to the 6F5 grid cap or wire, if the two tubes are placed very closely together, as they sometimes are in modern radio receivers. The remedy is obviously proper shielding, to prevent electro-static or capacitive coupling between the two elements of 6F5 grid and 6F6 plate.

Proceeding to the detector stage, the

circuit may appear as shown in Fig. 5.

In a 6H6 tube, usually one set of elements will be left unused. If in the more complicated sets it is desired to separate the functions of detection and automatic volume control, or to use noise suppression or other special circuits, then the two elements find use. In a set using automatic frequency control or in a set designed for operation in frequency modulation reception, both elements of the 6H6 are utilized.

The simple circuit shown is part of many receivers and basically important. One plate of the diode receives an a.c. voltage, since the plate and cathode are effectively across the tuned circuit of L & C. This alternating voltage is changed by half-wave rectification to a series of d.c. pulses. The d.c. pulses correspond to the carrier wave of the station which broadcasts. The a.c. pulses superimposed or put on top of the d.c. represent the audio signals sent out by the radio station.

The purpose of the 50 mmfd. condensers is to filter out the radio frequency which may be varying at the rate of 460 kc. per second. In a super-heterodyne radio receiver, there is what's called an intermediate frequency. The i.f. of intermediate frequency is standardized for broadcast sets at 455 kc., but many sets use 456, 460, 260, 175 or some other frequency. Most up to date or new sets use 455. The diode detector is used to rectify this radio wave at the frequency of the i.f. circuit.

If the 50 mmfd. condensers shown do not filter out or by-pass to ground the radio wave voltage and current, the set will not tune to the radio station properly. That is, when tuned for resonance or loudest volume, distortion will be evident; but if slightly detuned off the station the tone may be normal. This circuit may be checked by disconnecting the small 50 mmfd. condensers and checking them for leakage, or trying new ones in their place.

If the volume control resistance is too high, distortion will result. This is the most common trouble next to a bad contact in the volume control. As the control is used, it is turned thousands of times, and eventually wears out. When it becomes worn, scratchy sounds may issue from the receiver's speaker as the control is rotated. In some controls, it is possible to effect a repair by using carbon tetrachloride, a liquid solvent available from the drug or chemical supply house, to clean the control. Most frequently the simplest and best, though not least expensive repair, is to replace the control with a new one.

Other troubles which are common in the a.v.c. or automatic volume control circuit are: open a.v.c. series resistor and leaky .05 grid return by-pass condenser. If a magic eye tube such as the 6E5 or 6U5 is connected across such a leaky condenser, the eye may flicker due to the leaky voltage drop. If the condenser is open, poor recep-

tion towards the low end of the receiver dial scale may be expected, also, loss of volume. Too, the magic eye tuning indicator, if one is used, may flicker when the modulation of a broadcast signal takes place, as when there is a speaker or music on the air. In the silent periods, no modulation, the eye may remain stationary.

If the condenser in the tuned input circuit to the 6H6 detector is open-circuited, due to a broken lead or other reasons, the set may not tune to the station, but will sound better off the station. For example, WEAJ might be on 660 and the set, ordinarily, would be tuned to 660 for best reception. However, since the condenser C in the tuned circuit is open and not connected reception may be best at 662 or 658. The reason is that the diode circuit is not resonating. An open coil might cause similar trouble, although usually it will kill the set entirely. A simple test to determine whether or not the circuit is operating satisfactorily insofar as the tuned circuit capacitor is concerned, is to bridge an equivalent unit across it and observe the result. A vacuum tube voltmeter might also be used to check voltage across the tuned circuit, maximum for resonance.

Before going to the i.f. or immediate frequency and mixer circuits, it may be well to set down the elementary theory of the superheterodyne.

If an oscillator produces an alternating voltage, that voltage when com-

BUD CONDENSERS for Efficiency — Economy

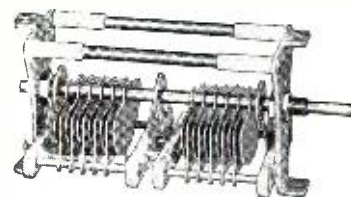

JUNIOR TRANSMITTING CONDENSERS

The ideal transmitting condenser for most amateur requirements. They are made in single, dual and U.H.F. types in a large variety of capacities and air-gaps. A well-built condenser at an economical price.

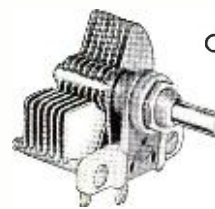

MIDGET CONDENSERS

The favorite for receivers and low-power transmitters. They feature Alsmag 196 insulation, ruggedly soldered brass rotor and stator sections and accurately fitted bearings.



Write for your
copy of the No. 241
BUD Catalog

BUD RADIO, Inc.
CLEVELAND, OHIO

lined with a second voltage will be the sum of the two if the two voltages are in phase. If there is a phase difference, which really means a frequency difference, the voltages will not exactly add and cancel as they go through the cycle. Similarly, two voltages of different frequency will add and subtract from each other. If one frequency is 100 cycles and another is 400 cycles, the sum will be 500 and the difference or net frequency will be 300. Not only that, but if the fundamental frequency of the oscillator is 100 cycles and its second harmonic is 200, the second harmonic will "beat" with the 400 and produce net frequencies of 400-200 equals 200 cycles and 400 plus 200 equals 600 cycles.

The oscillator, sine wave generator of alternating voltage, may have a frequency for an i.f. of 460 kc. that amounts to 460 plus 660 or a net frequency in the oscillator L C tuned circuit of 1120 kc. The oscillator is usually higher in frequency than the received broadcasting station, since the second harmonic of the oscillator will then be out of the band, or far enough away to not cause interference troubles. If the upper limit of the band is 1600 kilocycles, an oscillator on 800 kc. will have a 1600 kc. second harmonic. The i.f. 460 plus 800 equals 1260, and 1260 is the lowest frequency to which the set can be tuned without harmonic interference.

The superheterodyne set-up may be illustrated as shown in Fig. 6.

The mixer circuit shown is used by a great many sets. Older radios may use some different form of oscillator circuit but all are basically the same. If the oscillator is working, a negative grid bias will be developed, and this may be checked by putting a voltmeter from oscillator grid to cathode. The circuit will be detuned by application of the voltmeter, unless an electronic form of voltmeter having negligible loading on the circuit is employed for measurement. D.C. resistance measurements may be made of the coils in detector and oscillator circuits, these resistances being very low, seldom higher than 1 or 2 ohms.

The coil in series with the cathode of the oscillator in the 6SA7 circuit may be burned out, necessitating replacement. A d.c. ohmmeter check from cathode to ground quickly locates this fault. The electron current within the tube may be high enough in certain radios to be amplified even though the plate voltage is removed. This is because the electrons are attracted toward the positive screen and keep on going, because of their velocity, until they pass through the screen and hit the plate. Unless there is plenty of gain or amplification after the mixer this is unlikely to happen, but can occur in sets having a low i.f. and high gain or two stages of ordinary 455 kc. i.f. gain.

The automatic volume control d.c. bias may range from zero to minus 25 volts, depending upon the size of the antenna and the number of tubes in the radio. The field strength in microvolts-per-meter also determines the amount of voltage the receiver will pick up and rectify into d.c. potential.

As the resistance of the a.v.c. circuit is very high, the voltmeter connected to it to read that voltage must also have a high resistance or power will be absorbed from the circuit and no real indication of the voltage will be obtained. A 1,000 ohms-per-volt meter connected across the .05 condenser will not indicate accurately. Even a 20,000 ohms-per-volt meter will be inaccurate and only a d.c. vacuum tube voltmeter will give useful indications. A magic eye tube, 6E5 for 0-9 volts and 6U5 for 0-22 1/2 volts, will be a satisfactory indicator and consume no power nor will it load the circuit. Magic eye tube data may be found in any tube manual.

Coming next to the intermediate frequency circuit, which is "excited" (supplied voltage) by the mixer, we have the circuit shown in Fig. 7.

If the receiver is working from the 6SK7 plate back to the detector, as evidenced by the fact that when the 6SK7 is pulled out of its socket a click is heard in the loudspeaker, and the 6SA7 produces no such click, the trouble would lie between the grid and output circuits of the 6SK7 i.f. stage.

A plate and screen voltage check would be made as a matter of routine, using the d.c. voltmeter. No plate voltage would indicate an open circuit and the resistance of the coil, 10,000 ohm

resistor and shunt condenser would be checked. If the .1 mfd. condenser were shorted (which is common) the series resistor of 10,000 ohms might be burned up, which would be an obvious and visible defect found by sight inspection of the wiring. If the tube gain seemed to be low, and the screen voltage were checked, too low voltage of 10 or 20 volts might be found. With an ordinary 1,000 ohms per volt meter the reading might be 50 volts, with 20,000 ohms per volt meter (higher resistance and less current draw) the voltage might be indicated as 60 to 80 volts and with a vacuum tube voltmeter (no current draw) the screen voltage might be 80 to 100 volts, the actual d.c. voltage on the screen element of the 6SK7 tube.

With the power turned off, receiver plug out of the outlet, an ohmmeter test could be made to show the resistance values of the circuit. The manufacturer's service sheet should be at hand, if possible, although with experience and a knowledge of basic tube data characteristics and circuit data is not altogether necessary to the diagram for a particular receiver; but such diagrams are very helpful and speed the work.

In the i.f. stage shown in the sketch, the cathode resistor is sometimes left out entirely, with bias for the grid being supplied entirely by the a.v.c. network. Also, it is occasionally seen that the shunt across the resistors is left out, reducing tube gain due to degeneration. The designer of such a receiver deliberately introduced the resistor to limit gain in that particular stage, under such conditions, so that either oscillation would not result or that the next tube would not be overloaded with an excess of voltage.

-30-

As I See It!
(Continued from page 9)

ponderance of dishonesty prevails. The same goes for the radio schools, for the tie-up between what this radio instructor was purported to have said and the behavior of these dishonest service shops is so close, as to enable someone to say that it is the educational agencies which are, in a way, responsible for the so-called thievery which surrounds the operations in the radio servicing field. In other words, the article is also an indictment, perhaps more implied than actually stated, of radio schools as well as radio repair shops.

Recognizing the 4,000,000 circulation of *READER'S DIGEST*, the repercussions from this article are going to be tremendous; in fact so much so, that servicemen will have to take steps of varied kinds to offset the effects of this article. Radio schools, likewise, will have to take some steps to offset the detrimental effects of such unfair and undeserved implications.

We appreciate, as does every man who reads these words, that the ranks

GL-807

ONLY
\$3.50



UP TO
75 WATTS

60-MC FM INPUT

with
1/4-WATT DRIVING POWER

NO NEUTRALIZING
QUICK BAND CHANGE

Free

Complete Ratings of GL-807 (GET-756)

A Tribute to the Radio Amateur (GEA-3052A)

General Electric, Section 161-13A, Schenectady, N.Y.

GENERAL ELECTRIC

161-13

of the servicing industry are not pure and unsullied—that there are men who are dishonest in their dealings with the public—but that is so in every field, technical, commercial, or professional. As damaging as this testimony may appear upon paper, we cannot believe, and do not believe, that 60% of America's radio servicemen are dishonest. We have every confidence in the fact that if these investigators had visited more than 1% of the thirty odd thousand radio servicemen in this country, they would have found a different picture.

It is useless in these columns, since RADIO NEWS is not a consumer publication, to present a defense for the serviceman, for it is only radio-minded people who read RADIO NEWS. It is of far greater importance to sound a clarion call to the radio servicemen of this nation to take steps to offset this wholesale suspicion which has been cast upon the industry. There are some who will say that perhaps the best thing to do is to forget about this article in READER'S DIGEST. With this I do not agree. It is the function of every local association to take whatever possible steps they can by contacting the local Chamber of Commerce, the local Better Business Bureau, the local Kiwanis or Rotary or Lions Club, or whatever businessmen's association exists, in order to establish the integrity of the radio servicing personnel in the community. In order to offset this tremendously bad publicity, it is imperative that wherever possible local newspapers should be brought into the picture to investigate the local situation.

Such effort calls for cooperative movement. In those communities where there are but a few servicemen in a town, those of several counties should get together and work together in order to remove this blot upon the name of the servicing industry. Without intending to be an alarmist, we cannot belittle the import of this situation. The contents of this article in READER'S DIGEST was called to our attention by a number of people the very day that the magazine appeared upon the newsstands. The READER'S DIGEST is the most popular monthly publication in America and its columns carry a tremendous amount of weight. We have every reason to believe that the experiences mentioned in the article are true, for we do not think that either the magazine or the author have any personal axe to grind. It would be fine to be able to find some excuse or extenuating circumstance to justify some of the acts described, but it is difficult to do so. I doubt very much if anybody can find some reason which explains the right to make a charge for work claimed to be done when the work was not done, or for the sale of a tube or part, said to be installed, when that tube or part was not installed.

The only complaints that I have with the article are that I do not think the

test to be as fair as the author claims it to be; that it is not right to condemn thousands of entirely innocent men whose work is vital to the education and entertainment of the nation's public, when these people have no means of proving themselves for they do work for the same people and under the same conditions as those who are classified as dishonest. . . . *Radio servicing is not a racket.* It is all right to expose rackets when they are obviously so. But that is not so with radio servicing. . . . Despite what this article claims, I say that there are more honest men doing radio service work than dishonest men, for it would be impossible for an industry embracing more than 30,000 individuals and doing an overall business of more than 100 million dollars a year, to continue in existence for 15 years, when most of the men are dishonest. . . . Third, I do not think that it is possible for a person to come to a definite conclusion concerning more than 30,000 people by testing or checking 304. That's just about 1 per cent and unless my memory fails me, the general requirement for conclusions from surveys embracing between 30,000 and 50,000 people is at least 5 per cent returns—usually 10 per cent.

Concerning the nature of the defect as a test, I don't think that it was fair, for it placed the service shop on the spot. . . . Radio servicing is a business and can survive only as such, hence it is not right to feel that the honest act is to charge nothing or a trifling amount for having found the loose connection or the loose tube. . . . What I would like to know is whether or not these investigators visited any service shops which had a fixed minimum charge for inspecting a radio receiver. . . . Suppose that a shop had a 1 dollar minimum inspection fee. . . . Would this shop be considered honest or dishonest for making this charge? After all a dollar is not a trifling sum. Who is more honest—the man who has no fixed inspection charge and makes no charge, although he has done work, or the man who has a fixed charge and which charge is known to the customer and who charges the customer for having found and remedied either of these trifling defects? I am not presenting this argument in defense of those men whom the author calls dishonest, for it is morally impossible to find a defense for dishonesty. . . . What I am trying to establish is where such conditions would fall. Are they in the honest group of 109 or in the dishonest group of 195? This would alter the percentages.

I have received too many letters over a period of twenty years to believe that servicemen in general are dishonest. On the contrary, I think that they are most sincere. Something must be done quickly to overcome the stigma that has been thrown on the serviceman. How this can be done is problematical. One suggestion would be for each and every serviceman to talk to the editor of his local newspaper and

explain matters fully. Furthermore he would suggest that an investigation be made of his establishment in order that a complete picture could be made of the conduct of his business.

It matters little what steps are taken in order to combat this "blitz," but every one of you must realize that something must be done as quickly and as effectively as possible. Just why Mr. Riis should pick on the radioman, particularly at this time, is not known. It is a well established fact that the average income of the serviceman is far below that of other businesses. Many servicemen have gone overboard in keeping their prices down, which reminds us that as insurance against

**More Business for You!
through RCP
Test Equipment!**

**RCP-661
ELECTRONIC
MULTITESTER**

ONLY
\$34⁹⁵



**MAKE MORE TESTS
BETTER... FASTER!**

Make complete checking tests on AM, FM and television receivers under actual operating conditions, without disturbing the circuit constants! RCP Model 661 has all the newest, needed ranges, including capacity measurements from .00003 mfd. to 1000 mfd. Vacuum Tube DC voltmeter impedance 160 megohms on high ranges, 16 megohms on low. Vacuum tube AC voltmeter input capacity only .00005 mfd. Look at all the useful ranges of this test instrument value:

DC volts—0/6/30/150/500/1500/6000
AC volts—0/6/30/150/600/1500/6000
Ohms—0/1000/10,000/100,000/1 meg/100 meg/1000 meg.
Capacity—0/.001/.01/.1/1/10/100/1000

**RCP-702
SIGNAL
GENERATOR**

ONLY **\$25⁴⁵**



Continuously variable from 95KC to 100 MC. Up to the minute in circuit and mechanical design.

NEW FREE RCP CATALOG! Just off the presses. Great new catalog of RCP Test Equipment. Describes entire line. Send for your copy. See how much money you can save when you specify the lowest-priced quality line. Order Now! Avoid delays and higher costs.

**RCP
dependable
TEST
instruments**

RADIO CITY
PRODUCTS COMPANY, INC.
88 PARK PLACE • NEW YORK, N. Y.

such charges as those made by Mr. Riis, every service dealer should establish a minimum service fee.

As far as the servicing industry is concerned, certain conditions have been brought into the limelight. . . . As important as the serviceman may be to the American public, it is still necessary for him to conduct an honest business if he is going to survive. . . . It therefore falls upon the honest group to maintain the reputation of the industry, for with such unpleasant publicity disseminated among the public, every future service will be under suspicion, no matter how sincere and honest it may be. . . . A job is cut out for every local association and no one radio service organization in any town is big enough to feel that it can do without the cooperation of the other good service shops. . . . If anything is going to be done to offset the bad taste created upon the palate of the American public by this article, it's got to be done town by town, city by city, by the serviceman in those towns and cities, in concert with the business elements.

What I have said in these columns is by no means a complete discussion of this subject, for the survey described

is one of the most important articles concerning the radio servicing industry which has ever appeared in print. . . . I am anxious to hear the comments of servicemen who have read the original article as it appeared in **READER'S DIGEST**.

-30-

Police Radio (Continued from page 20)

servation boat equipped with 2-way radio.

Paw Paw has four receivers in operation, on the *Michigan* state frequency 1642; *Indiana* state frequency, 1634; on the *Michigan* medium frequency, 2442; and one CW receiver. At present, due to the acute shortage of radio men, there are only two other ops at the Station, Fred Blink and Bob Evans.

Keene also services *Niles, Michigan* police station WRQF, and he is also laying out tentative plans for a 2-way *Motorola* installation at *Sturgess, Michigan*.

Kalamazoo, Michigan, WAMG, under the supervision of James A. MacGregor operates on 200 watts on 2442 kc. Most of the equipment was built by MacGregor, however, he has also purchased some *Motorola* mobile equipment.

Mac has a co-ax antenna installed on top of a water tower outside the city limits which he uses for receiving purposes. The transmitter is located in the city police department building.

W. H. Perdew, radio engineer of WQLO, *Evanston, Illinois* has recently rebuilt all of his old style *GE* mobile receivers discarding everything except the case. The receiver he now uses is a modern crystal controlled circuit of his own design. His next step is to rebuild the old style *GE* transmitters in the same manner only preserving the case. They will be crystal controlled with an output of 15 watts.

Perdew has ten squad cars and one patrol wagon operating on 31,780 with a 50 watt station house transmitter on 33,940. Two frequencies are monitored at the station, *Cook County* on 31,900 and his cars on 31,780.

Ed. Melka, of *Winnetka*, really has a lot of *Illinois Lake Shore* equipment under his wing. Ed has a total of six municipalities which he services including *Kenilworth, Lincolnwood, Skokie, Morton Grove, Desplaines* and *Arlington Heights*.

Kenilworth has two cars and one main station on 31,900 kc. *Lincolnwood, Morton Grove*, and *Arlington Heights* have one 2-way car, taking service from *Cook County*, operating on 33,780 kc. *Skokie* has two cars and a main station. *Desplaines* has two cars, a fire department truck and one main station on 37,900 kc. This would be enough work to keep any man busy, but Ed also runs a radio service shop in conjunction with the village shon in *Winnetka*.

Hiland B. Fillmore, W9BEL, relief op at *KGZC, Tulsa, Oklahoma*, recently dropped in at *Chicago* on his way back to *Tulsa* after being released from the army because of his superior knowledge of test instruments making him more vital to defense in a civilian job.

Fillmore had been a sergeant in the army and had an instructor's job prior to his release. He will report back to his job in *Tulsa* in an instrument concern.

He is an old timer in radio starting back in 1921 using a 2 kw. spark. He formerly worked at the *Elgin Watch Company* standard frequency station W9XAM-W9XAN in their observatory from 1929 to 1935. Besides working as a marine op for the *Clyde Mallory* lines, he has worked with *R. M. E. Mfg. Co.* at *Peoria*, and the *Bendix*

radio in police sales. He has been in *Tulsa* since 1939 working both as relief op at the *Tulsa Police* radio station *KGZC* and with the instrument concern. He is also connected with the 125th observation squadron as technical sgt. in radio.

Co-operation with the smaller municipalities in *Cook County, Illinois* is the keynote of communication officer Lec Fetcher's county radio system. *Cook County* has three stations in *WSCI, Morton Grove, WSKE, Willow Springs*, and *WSKD, Homewood*. These stations operate 2-way with their cars on 31,900 kc. They have also set up a frequency of 33,780 kc. where by any small municipality in *Cook County* with only one or two cars, can set up a transmitter on this frequency and a receiver on 31,900 kc. and have 2-way communication with the nearest county station.

Since there are many small suburbs and townships in *Cook County*, many of them have already taken advantage of this idea and are enjoying 2-way communication with very little expense. In this manner, it is possible for the municipality to summon aid from other nearby towns through the county station.

-30-

What's New in Radio (Continued from page 38)

Seamless Aluminum or Copper Tubing, tinned or untinned. Not only does this wire afford maximum protection against moisture, corrosion, alkalies, etc., but it also affords extra protection against mechanical damage and fire hazards.

Precision Metal Shielded Wire is available in lengths up to 50 feet and may be had in a variety of sizes from a single conductor with an outside diameter of .018 inch to multi-cable types of one inch outside diameter.

This new Shielded wire is compact, light in weight, neat in appearance, easily bent to the shortest radius and may be stripped quickly, easily and cleanly.

A beautiful brochure which tells the complete story of *Precision Metal Shielded Wire* will be sent free to those requesting same from the factory.

Low Priced Recorder

Talk-A-Phone Mfg. Co., Chicago, announces a new, unusually low-priced Complete Home Recorder. It is actually three instruments in one: (1) an easily operated



Recorder; (2) an efficient Record Player; (3) a complete Public Address System, including amplifier, Crystal microphone, and special heavy-duty 6 1/2" Dynamic Speaker. Plays back the recordings it makes, or plays any standard 10-inch and 12-inch commercial phonograph records with the cabinet lid closed. When used as a Public Address System, develops full three watts power output. Employs five tubes, including Rectifier and Electric Eye Volume Indicator. The *Talk-A-Phone* Portable Recorder is housed

MODERN PARTS for
MODERN CIRCUITS
THAT HAVE BEEN
"Designed for
Application"
CATALOG UPON REQUEST

JAMES MILLEN MFG. CO. INC.
150 EXCHANGE ST. MALDEN, MASS.

RADIO ENGINEERING
DEGREE IN 2 1/2 YEARS

Complete Radio Engineering Course in 27 months. Bachelor of Science Degree. Prepares you for important positions in National Defense and Industry. Radio (television, talking pictures and the vast electronic field) offers unusual opportunities for trained radio engineers. Recognized by the War Department for the training of radio operators. Courses also in Civil, Electrical, Mechanical, Chemical, Aeronautical Engineering; Business Administration and Accounting. Tuition, living costs low. World famous for technical 2 1/2 year courses. Special preparatory department for those who lack required high school work. Students from all parts of the world. 58th year. Enter September, January, March, June. Write for catalog.



FOUNDED
IN
1884

1691 College Ave. Angola, Ind.

TRI-STATE COLLEGE

in a durable, attractive carrying case finished in striped airplane-luggage cloth. Size: 16" long, 16" deep, 14" high. Weighs approximately 45 lbs. It's the last word in an exceptional quality, low-priced Complete Home Recorder.

New Hickok Instrument

Here is the latest *Hickok* measuring instrument Model 202 that gives more measurements while the set is in operation without danger of damaging the test instrument due to overload.

A. C. Voltage in five ranges to 1000 volts with input impedance of approximately 2.5 megohms; D. C. Voltmeter in five ranges to 1000 volts with input impedance of 14 megohms; Five ohmmeter ranges to 1000 megohms; Five Milliamperer ranges to 1000 milliamperes.

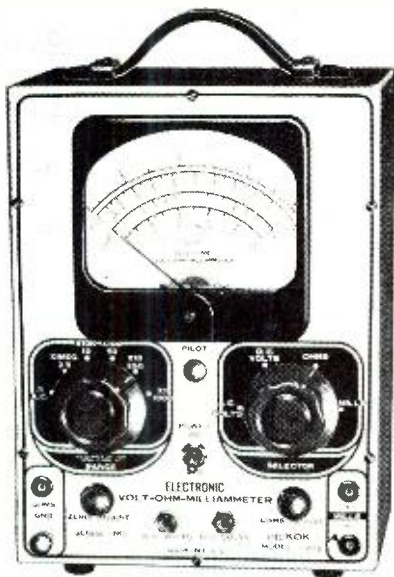

The meter is a large 5" rectangular type, with over 17 inches of total scale length. Pilot light is located on front panel.

The power supply is entirely self-contained and operates on 110 volt 50-60 cycle A.C. Complete with voltage regulator tube giving self contained voltage regulation.

Manufactured by *The Hickok Electrical Instrument Co.*, 10301 Dupont Ave., Cleveland, Ohio.

New 10-Watt Audiograph Amplifier

A 10-watt amplifier, for use in call systems, small restaurants, and other places where only low power is needed, has just been announced by *John Meck Industries*.



1313 W. Randolph St., Chicago. Listing at only \$25.00, this unit offers microphone and phonograph input channels, each with separate volume control. Dual action tone con-

trol affords accurate adjustment for all applications. Four and eight ohm outputs provided for use with single or dual speaker systems, or the unit may be arranged for use with many speakers. Field current is supplied for operation with dynamic speakers. This amplifier is available with a dual speaker carrying case or mounted in an easily portable case with single speaker.

National Defense & Radio

(Continued from page 32)

tutions that have been affected have to an extent eased the situation. These include copper flashed steel rods for grid supports, oxidized steel for plates and iron grid wires with nickel sleeves. Whether or not metal tube manufacture will be curtailed soon is problematical at this writing. Pleas from manufacturers pointing out that glass envelope tubes will mean larger chassis and more shielding. The consequent use of more metal than in the supplanted metal tubes, may aid in adjusting this situation. The importance of the radio tube to the maintenance of receiver operation may also serve towards improving the priority rating of nickel and other essential ingredients, thus assuring manufacture current with demands.

The chassis of 1942 will be either of steel or iron, copper flashed or scrap metal sprayed. Thus far, the plastic chassis for fall production does not seem a probability. This has been prompted by die problems and present fragility of structure. If plastic chassis do come, they may take the form of soybean material, not only because of the shortage of formaldehyde and phenol, but because of the natural resultant sturdiness of soybean plastics. Although at the present, soybean plastics have a tensile strength of one half that of steel, it is possible to increase its strength by increasing the proportion of the Egyptian ramie plant, used in the cellulose fibre. The ramie plant thrives in many parts of America, and is used quite extensively by *Henry Ford* in plastic development work. It is understood that wheat and corn may be substituted for soybeans, thus taking care of some of most troublesome agricultural problems.

Hookup wire will find itself covered with a coating of cellulose acetate instead of silk, cotton braid or cotton, in next year's receivers, because of a lack of the latter insulation materials. In some instances, the standard insulation materials have been reduced to 50% of their former insulation properties to affect the necessary material saving. However, many receivers are using the plastic coated wire that has been reported to have passed breakdown and heat tests, most successfully.

Because of the shortage of screw machine parts, practically all of the parts formerly made this way, will hereafter be stamped out, with steel being used. These pieces will be plated with either of many platings available. At present some cadmium is being used. This will, however, soon be discontinued because of an imminent shortage. Flashing and spraying as previously described, will then be called into service. With the coming of the stamped parts, the service man should remember that it will be, hereafter, necessary to replace the complete units, rather than just sections, for such sections may be difficult to match. In view of this, the service man may find his billing to the customer a bit higher than usual. A prior explanation is accordingly suggested. Mica, an important mineral, is

(Continued on page 56)

Video Sets More Costly

LIKE many other lines requiring metal and wood components, television receivers will cost somewhat more than estimates of a year ago. It is expected that price stepups will average somewhat higher than the 10 per cent already indicated by one maker.

It is apparent that the bulk of immediate sales will be outright cash purchases. Television is still regarded as a luxury item by retailers and the type of immediate buyer is not the kind that bothers with installment purchases. Hence, on this end, dealers are pleased.

* * *

BLILEY ELECTRIC CO., ERIE, PA.

Most - Often - Needed

RADIO DIAGRAMS

and Servicing Information

4 OUT OF 5 CIRCUITS YOU NEED

In these easy-to-use complete manuals you have all the diagrams you really need. Over 80% of the sets you service every day are included. Use these important, hint-giving, trouble-shooting circuits to make your job easier. You must be satisfied, or your money back is guaranteed.

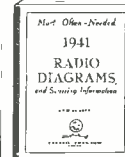

NEW 1941 VOLUME

Let this latest manual give you all 1941 circuits you will ever need, introduce you to new radio developments, help you to do better servicing. Includes clear schematics, alignment data, service hints, I.F. peaks, and parts lists. Compiled by M. N. Beitman, radio serviceman, author, teacher. 192 pages, 8 1/2 x 11 inches. The greatest value in radio diagram manuals. Net only **\$1.50**

MOST POPULAR 1940 SCHEMATICS

Covers all popular models of 43 manufacturers for this important radio year. Data on F.M., 3-way portables, intercoms, recording. Service hints, alignment suggestions. 417 models. 208 pages. Postpaid, only **\$1.50**

1939 DIAGRAM MANUAL

Another condensed manual of most-popular diagrams you need. Circuit data, hints, and information are time-savers and money-makers for you. Let these diagram manuals guide you to easier and faster service work. Diagrams of 39 manufacturers. 192 pages. 8 1/2 x 11 inches. Net price **\$1.50**

1926-1938 DIAGRAMS YOU NEED

The most popular manual of the series. Will pay for itself with time saved the first day of use. 427 diagrams of most-serviced radios in your shop every day. With parts lists and alignment information. 244 pages. Large size, 8 1/2 x 11 inches. Biggest value at **\$1.95**

SEND COUPON OR SEE YOUR JOBBER

SUPREME PUBLICATIONS, 3727 W. 13th St., Chicago, Ill. Ship the following manuals. Will pay for itself under money back guarantee terms. I am enclosing \$..... in full payment. Ship postpaid. NAME..... R.N-S-D (Write address below and send this corner.)

SAVE UP TO 50% FACTORY-TO-YOU

9 BANDS (ON 6 DIAL SCALES)

20 TIMES BETTER FOREIGN TUNING with SUPER BAND SPREAD RADIO!

30 DAYS TRIAL

UP TO \$50.00 TRADE-IN

WRITE for big FREE catalog. New 1942 models include Radios, Radio-Phonos, Home Recorders, Sensationally low factory-to-you prices: \$11.95 to \$212.00... up to 16 tubes. (User-Agents Wanted).

MIDWEST RADIO CORPORATION
DEPT. 11-B CINCINNATI, OHIO

NEW! 1941 MODEL Pocket Tubes Batteries Radio

DURABLE PLASTIC CABINETS
Dual Bands-Magicenna-Microdial

Fit your pocket or purse. Wt. 6 ozs. Small in case & package. Receives standard & some short wave, PATENTED POWER RECTIFIER. No tubes, batteries. Historic easy tuning slide "MICRODIAL" M.L. OF ILL. SAYS: "MIDGET RADIO WORKS FINE!" ONE YEAR SERVICE GUARANTEE!

Sent complete ready to listen with instructions & tiny phone for use in homes, offices, hotels, in bed, etc. SIMPLE TO OPERATE—NO ELECTRICITY NEEDED!

SEND NO MONEY! Pay postman only \$2.99 plus postage charges on arrival or send \$2.99 (Check, M. O. Cash) and yours will be sent postpaid. A MOST UNUSUAL VALUE! ORDER NOW! FREE! "MAGIC-ENNNA"—ELIMINATES OUTSIDE WIRES!

MIDGET RADIO CO. Dept. HG-9 Kearney, Nebr.

EASY TO LEARN CODE

It is easy to learn or increase speed with an Instructograph Code Teacher. The quickest and most practical method yet developed. Available tapes from beginner's alphabet to typical messages on all subjects. Speed range 5 to 40 WPM. Always ready—no QRM.

MACHINES FOR RENT OR SALE
The Instructograph Code Teacher literally takes the place of an operator-instructor and enables anyone to learn and master code without further assistance. Thousands have used and endorse the Instructograph System. Write today for full particulars and convenient payment and rental plans.

INSTRUCTOGRAPH COMPANY
Dept. NR, 4701 Sheridan Rd., Chicago, Ill.
Radio College of Canada, 54 Bloor St. West, Toronto.

FOR DEFENSE

BUY UNITED STATES SAVINGS BONDS AND STAMPS

AMERICA ON GUARD!

Above is a reproduction of the Treasury Department's Defense Savings Poster, showing an exact duplication of the original "Minute Man" statue by famed sculptor Daniel Chester French. Defense Bonds and Stamps, on sale at your bank or post office, are a vital part of America's defense preparations.

ON SALE AT YOUR POST OFFICE OR BANK

also on the "problem" list. Formerly, almost exclusively imported from India, it is now being mined domestically and in South America and Canada. Unfortunately, the sources of supply, thus far, are not as productive as anticipated. However, mineralogists assure the government that it will soon be possible to secure mica with as clear a content and as sturdy a body as necessary. In the meanwhile, all efforts to conserve will be made. Thus, the number of trimmers on receivers will be reduced, and other variable means of alignment will be substituted. Mica condensers will also find themselves quite scarce in the new receivers. And speaking of mica condensers brings up the plastic question again. Because of the restrictions on bakelite used in most instances to mold mica condensers, ceramics or even cellulose acetate will be substituted to produce whatever mica condensers may be deemed absolutely essential to receiver construction.

That beautiful mirror like finish found on escutcheons, instrument panels and countless parts will not be so prevalent in equipment of 1942. For chromium, the metal that affords this hard bright, practically indestructible finish, has been placed under full priority control. In defense needs, the metal is required for hardening of steel, the production of high speed cutting tools, the manufacture of refractory brick for lining steel furnaces and many other chemical uses. Most of the national supply of chromite ore in recent years has come from Africa, the Philippines and Turkey. Since the government stockpile is not large enough, and consumption is moving up, and in addition increasing pressure on shipping space may restrict imports in future months, conservation is essential. Unfortunately there are no direct substitutes for this material. However, receiver and equipment designs are being so converted, with such a variety of impressive effects, that the change will be actually in the direction of improvement.

Portable receiver design will soon be changing, too, because of the restrictions placed on the production of zinc. This metal, essential to the manufacture of dry batteries, is also essential to the production of military brass that serves to fabricate shells. And, it is quite natural that the call for cartridges will become increasingly great as the months go by. Here again we have the situation of having a plentiful natural supply of the ore, but not sufficient production facilities or power to create the tremendous quantities necessary. According to present estimates, the demand for zinc in 1941 will be in the neighborhood of 1,165,000 short tons, with only 890,000 to 950,000 tons being produced. Thus there will be an over-all shortage of from 215,000 to 275,000 tons.

In view of the anticipated shortage, a variety of economies will be instituted, in addition to the many already in practice. Accordingly, a substantial quantity of cells will be produced, but not sufficient to take care of the increased portable set production. Thus, the recently introduced compact lead-cell batteries will be swung into play. This means that for 1942, rectifiers, inverters and hydrometers appear to be on the road to playing a popular return engagement.

The restricted production of batteries will also bring about a new method of standardization, which will mean the elimination of many duplicate styles and types. This, in effect, will greatly simplify matters for manufacturer, service man and consumer. And thus, actually, the enforced conservation move will serve to clarify a somewhat confused situation.

Increased use of substitute materials for test and meter instrument cases, such as

lead, steel and iron, will introduce alignment and calibration problems that will change the customary procedures of test operations for the service man. These new devices will be as efficient as heretofore, but in view of the new materials used and their characteristics, many design changes may have to be put into effect. Thus their operation will, of necessity, be different from previous types.

According to most manufacturers, production of straight AC receivers is expected to continue at as great a production rate as possible with the materials available. Silicon steel laminations are coming through with comparative regularity. However, should critical needs for this material arise, designs are already available to make the necessary changes both in the power and audio systems. In other words, a flexible production is being planned so as to permit any sudden changes demanded by shortages.

-30-

Aviation Radio
(Continued from page 32)

This must be avoided by allowing sufficient time between starts for the motor to cool off.

Master switches should not be turned on with equipment switches "on," unless they are connected to "master starter relays." If a master switch is not connected to a starting relay, burned contact strips, corrosion and undue wear will inevitably result, if it is turned on with other equipment drawing current. Where starting relays are used (and it will be found that they exist in approximately 75% of all aircraft containing a generator and battery system), they will be connected usually in series with the master switch and are designed for taking an "instantaneous-maximum-load."

Low voltage filter units for filtering out generator noises, etc., should be of high current capacity ratings; this is especially true of the chokes used. A 50% overload factor should be incorporated in the choke design by the technician making these units. This is done by figuring the maximum current requirements of both the radio and electrical installations. Viz., 50 amperes drawn by all equipment electrically operated. Add another 50% for the safety factor or overload factor, and this would give us a unit capable of carrying 75 amperes.

Very few lights in an aircraft will be connected in series with each other; parallel systems are usually employed. However, it has been found that certain instrument lights are connected in series, the total rating of these equaling the battery output voltage. These instruments are not too important in the safe conduct of the airplane and are usually equipped so that they are quite discernible in the dark.

In order to test the average electrical installation, all that is needed are the following: A good voltohmmeter; an extra battery (usually on a battery cart for external connection to the supply system); spare bulbs; a hydrometer and the necessary tools.

In testing any installation, the smallest and simplest troubles likely to develop are searched for, first; and these troubles are usually found "exteriorly." That is, they're surface troubles. Component by component to trouble source is the recommended procedure. Where a "two wire" system is encountered, and when making tests for likely short circuits, always use the "three way method," viz., test between conductors and airplane structure and between separate conductors and airplane structure, and/or insulated equipment. Where equipment cannot be readily checked due to its inaccessibility, the component should be removed and bench tested, always keeping in mind that the electrical system is of supreme importance to the safety of the aircraft while in the air; and in some instances while on the ground.

Careful checking should be the result of this one thought! Where a "one wire" or grounded system is used (where the frame

of the aircraft structure is used for return connection), make certain that no structural connection is loose or improperly bonded. The resistance of bonded connections and structural connections should not exceed .001 to .004 ohm; of course, this depends upon the length, cross sectional area of material, and the type of material being tested. A low range ohmmeter or buzzer connected in series with a battery should be used in making low resistance measurements, never a high range ohmmeter. Improperly connected structural members or improperly bonded connections are a source of radio interference, and because we are primarily interested in the operation of the radio equipment, care should be taken to ascertain the condition of all likely sources of interference and trouble.

Conduit should be supported with clamps as it crosses separate members; and these clamps should be so tightened and constructed so as to afford good bonding connection to the aircraft structure in all cases. When bending conduit, a swaging machine should be used. However, if the pipe is filled with sand, plugged, and bent over a good round surface, little difficulty will be encountered in making the proper angular bends.

Shortness of electrical wires is essential to proper operation of the entire system; and too, neatness of installation. All wires where connected into the terminal box (junction box) should be provided with terminals of appropriate size, commensurate with the connections they must fit. Never use small terminal connections of the "U" type where it is possible to obtain and use the "O" or circle type. Lockwashers should always be used to hold these terminals firmly to their main connection points. In some cases, where modification of the electrical installation is deemed necessary, it will be found that the number of terminals that must go over one machine screw makes it impossible to tighten the nut down correctly. In this case, a longer screw should be used, and where none is available, or because of installation difficulties one cannot be replaced, then the terminals should be fitted as tightly as possible to the screw with the nut and the whole assembly soldered, making certain that each terminal is soldered solidly to the main connection. The resultant connection should be painted with a good varnish, taped and shellacked. For various reasons the procedure just mentioned is discouraged, and is only recommended as a last resort to a "qualified" connection.

All electrical wires should be shielded and bonded; this prevents noise radiation. All shielded cables should be taped and shellacked to prevent "rubbing contact noise." Never re-route electrical wires unless the manufacturer of the aircraft recommends such practice. It is known that wires are routed in a certain manner to prevent magnetic disturbances; that is, they are routed so that the field of one wire will cancel the field of another. For this reason then, always replace wires in their first positions.

Due to vibration, certain connections invariably seem to come loose. This is quite true of connections made on the rear of certain panels not shock mounted. Landing light assemblies often require periodical tightening as well as those terminal connections located relatively near the engine or engines. If one will notice those connections made to the starter motor assembly, the generator, etc., one will see that cables leading to these are longer than necessary. The extra length being the slack required to cope with vibration which might be carried to connections with the result that they will loosen in time. Always check for this slack when repairing or installing new units mounted on or near the engine or engines.

The ignition system of the modern aircraft usually consists of the magneto or magnetos, switches, spark plugs, high tension cables, etc. We are only interested here as to their relations with the radio installation. Improperly adjusted spark plug gaps; loose switch contacts; unshielded high tension cables; mal-functioning magnetos, all go to make up the largest part of interference encountered in the radio installation. For this

reason, it is necessary that the radioman have a good working knowledge of the ignition system.

Where high tension leakage is found to exist, a probe antenna connected to the radio receiver will usually locate the area from which the interference emanates. Neon testing equipment will readily show up high tension leakage from cables, plugs, etc. There are a number of "standard" test units on the market which readily simplify finding leakage and mal-functioning ignition equipment.

It can be seen now, that the radio installation is quite dependent upon the electrical system for proper operation. Without perfect "coordination" of the two installations, the radio system will not function properly.

A few hints of what to look for when trouble develops: No voltage . . . no supply: check condition of battery, action of power relay, fuses. No charging indicated: check generator, ammeter, reverse current cut-out, voltage regulator, condensers, generator switches. Interference: check all bonded connections, condition of generator, check booster coil, ignition harness, magnetos, low voltage filter. No lights: check switches, fuses, bulbs, sockets. No current distribution to specific components: check cables and fuses and socket connections.

-30-

QRD? de Gy

(Continued from page 38)

Larry Lanphier of the Omaha station has now moved to Tulsa, Okla., as Station Manager and Roy Cox has been upped to Asst. Station Manager at Omaha. Here at WPDO we have finally got the CW rig on the state radio-telegraph net and are waiting for the final hokay from FCC. Which brings up an interesting point that in 1936 there were seven (7) experimentally licensed police CW stations and today there are about ninety-five (95) regularly operating outfits covering the U.S.A. However, here is a lil luff on the police ops. Some of the gang got the idea that they would like to see "First Class" on their tickets. So they petitioned the FCC to rewrite the regs to read "or after a year in a manually operated police radio-telegraph station." But Uncle comes right back with the sad dope that the Cairo and Havana conferences require one year aboard ship. 'Tis a sad, sad world, but the coppers will still have to take a ride on a boat for at least one year before they can have the top ticket, eh eh. Wx Bureau is putting out the lake weather every six hours this year instead of every twelve as heretofore. This will give the gang still running the CW equipment a lil more work to do. *Lorain Radio* says they now have over 250 ships on the Lakes equipped with their fone jobs. A guy ought to be able to make a living keeping those outfits in trim providing an arrangement could be made with *Lorain*. Seems to me they are bound to go bad once in a while way up in Duluth or over in Milwaukee or some such place and the local agency for the company would be worth while. Not a bad idee, what?

THIS may be a trifle long but we believe that Brother Norman Underwood, owner, operator, manager, etc., and etc., of Mobile, Alabama's, high power radio station, WLO, has something here: [Quote.] . . . I made a trip to France right after the war started and we carried some 16,000 bales of cotton. As this was what the Germans called "conditional contraband" and, according to their views, could sink a ship, I built a short wave xmitr and revr in an overnight bag which measured 5" by 11" by 19" to take with us if we had to take to the lifeboats. I used a 6L6 as crystal oscillator, ground a crystal for the 36 meter marine band and used a small non-spillable aircraft storage battery to run a genemotor which supplied the plate with 250 volts at 50 mils. I made wooden brackets for either end of the lifeboat which provided support for two oars which were the masts. I tried the rig out with about 25 feet of wire between the "masts" set up in the

lifeboat and contacted WBF at Boston while 2200 miles out. Not bad, with a total drain from the battery of 6 amps at 6 volts. I made other contacts, too, of course. It was a great source of satisfaction to the rest of the fellows to know that if we were forced to take to the boats we had means of notifying the world of our predicament. This was borne out by a news broadcast we heard, about that time, while we were in LeHarve. A German sub stopped a Dutch tanker and ordered them to the boats. The Captain sent the Mate and four other men in a boat over to the sub to point out that Germany was not at war with Holland but the sub commander said he had his orders and that he would sink the tanker in 15 minutes. This didn't give the Mate time to get back to the ship, so the 35 men left on the ship had to pile into the other lifeboat. Well, the world knew nothing of the incident until the men in the 5 man lifeboat, after six days at sea.

So, gentlemen, keep your flintlocks clean and your powder dry; they may be needed soon, and with a cheerio, ge, 73, GY.

-30-



Amazing New "WALSCO" STAPLE DRIVER

for radio men, electricians, or anyone doing stapling. Makes wire and cable installations twice as easy—much neater—saves half the time. Wires can be stapled in corners, behind pipes, into moldings—places never accessible with a hammer and ordinary staples. Drives staples even into walls, brick, mortar, etc. Magazine works automatically and holds strips of staples which come in several colors. Ask your jobber for demonstration and catalogue 41-C of all WALSCO PRODUCTS

or write **WALTER L. SCHOTT CO.**
5264 W. Pico Boulevard, Los Angeles, California



Great News! For RADIO and ELECTRICAL SERVICEMEN

The New Utility Tester

The **UTILITY TESTER** is a new kind of instrument for testing all electrical appliances—WASHERS, IRONERS, REFRIGERATORS, RANGES, VACUUM-CLEANERS, TOASTERS, PERCOLATORS, HEATERS, SUN LAMPS, AIR-CONDITIONING, MOTORS, ETC. The **UTILITY TESTER** enables every possible measurement necessary to service any electrical appliance.

SPECIFICATIONS:

3 Wattage Ranges: 0 to 5000 Watts A.C. and D.C. The **UTILITY TESTER** reads the actual consumption of any appliance, motor, etc., while it is in operation thus you can actually prove to the layman the actual cost per hour of operation.
6 Voltage Ranges: 0 to 1000 Volts A.C. and D.C.,
4 Current Ranges: 0 to 100 Amperes A.C. and D.C.,
2 Resistance Ranges: 0 to 3000 Ohms. The **UTILITY TESTER** reads all resistances commonly used in electrical appliances, and in addition reads extremely low resistances. For instance 1 1/2 ohms appears on the center of the low ohms scale and resistances as low as 1/50th of an ohm are easily read.

The **UTILITY TESTER** comes complete with portable cover, self-contained battery, test leads and all necessary instructions. Shipping Weight 11 pounds. **\$11.85**
Only

NOTHING ELSE TO BUY
SUPERIOR INSTRUMENTS CO.

136 Liberty St., Dept. RN9, New York, N. Y.



**QUICK, EASY WAY
TO TRAIN FOR
RADIO
in 8 WEEKS**

H. C. Lewis

I'LL FINANCE YOUR TRAINING
Mail the Coupon TODAY and I'll not only tell you about my quick, easy way to train for a good pay job in Radio, Television and Sound, BUT, I'll also tell you how you can get it and pay for it, in Easy monthly payments starting 60 days after 8 weeks' training period.

LEARN BY DOING
On Real Equipment in Coyne Shops
Simple, easy method of Practical Training. You don't need previous experience or a lot of book learning. You work on real equipment in the Coyne Shops at Chicago. This 8 weeks training prepares you for a job in service and repair work—we also offer radio operating training. Full details of this training will also be sent you when you send coupon.

**EARN WHILE LEARNING,
Job Help After Graduation**

We help you get part time work to help with living expenses and then give you employment service after graduation.

H. C. LEWIS, President
Radio Division, Coyne Electrical School,
500 S. Paulina St., Dept. 61-3K Chicago, Ill.
Dear Mr. Lewis:

Please send me your Big FREE Book, and details of your PAY-AFTER-GRADUATION-PLAN.

NAME
ADDRESS
CITY STATE



**SEND
COUPON
TODAY**



PART II

**Ultra High Frequencies
Serve Aviation in
Air Defense**

Beginning on page six of this issue is the first of two installments on UHF in aviation radio. Next month RADIO NEWS brings its readers part two of this revealing account by Charles J. Schauers . . . a comprehensive coverage of antennae for UHF. All the problems encountered in selecting an antennae for a particular service requirement for UHF transmission or reception, or both, are discussed in detail. By all means, don't fail to read the second installment of "UHF Serves Aviation in Air Defense" in the big fact-filled

OCTOBER ISSUE



ON SALE AT ALL NEWSSTANDS SEPTEMBER 24th

Serviceman's Experiences

(Continued from page 23)

ward my mouth.

"Woof!" I said.

In a calmer moment, I'd have known the trouble was further south than the mike if the speakers were dead, but I was so horribly rattled I couldn't think. I could hardly stand up.

"Woof!" I repeated, as competently as possible.

The senator, leaning sarcastically against the speaker's stand, asked: "Are you hungry, my boy?"

I couldn't have got redder—but I did get more rattled.

"WOOF!" I shouted desperately. *The loudspeakers, live again, flung the word at the audience!*

"WOOF!" they roared back to me as I sneaked around to the amplifier. As I passed Miss Crocker, she was smiling—like a spider smiles at a fly. Had no one been looking, I believe she would have stuck out her foot and tripped me.

I couldn't understand what had made the gear come suddenly good until I reached the amplifier. Al was there! Knowing I had brought no spare amplifier, he had driven over with one in his car just before the meeting. When mine had gone dead, he replaced it with the spare. He was not very glad to see me.

"You would-be patriot!" he snarled, "why don't you use your head? Get out!—I'll switch to the record when the time comes. And take that broken-down amplifier with you!"

Words and money aren't enough—sometimes a serviceman has to use his head to help his country!

-30-

Ham Chatter

(Continued from page 36)

W5JFS of Baton Rouge is a FB rag chewer on 160 fone.

W5HKJ of Kentwood has joined the La. 160 A.A.R.S.

W5IUJ, Pete, is another darn nice ham in N.O. Among other things, Pete is some times called Sambo.

W5HRX of Gulfport does a swell job in handling the La. and Miss. Gulf Coast Storm Net when the N.C.S. is absent.

W5HCJ works forty also.

W5IMT is working all the bands since he got that class A ticket.

W5JWI of Triumph, La., is going to high power soon on one sixty fone.

W5FSX is located in Potash, La., down near mouth of the Miss. river.

W5JRI can be heard thru the sound system of the local movie theater. (Hi!)

W5UK has dandy signal on ten and one sixty fone with his revamped 110 CM transmitter.

W5IMU is laboriously trying to get on ten meters.

Sam Eaton, local SWL, is like that with Louise.

W5IZX really thinks that Patsy likes him. Hi!

W5IKV, we understand, has quite a nice looking YL.

W4GJV of Memphis is fixing to center isle it soon.

W4FVN, David, still says that he does not like YLs.

W5JHM is working for Radio Parts, Inc., along with the President of the co. W5HHT.

W5IIA in New Orleans steps out quite a bit with the women he tells us.

W5IBD says he wants to be a physicist.

W5ZV, Margaret, says she likes ten meters better than any other band.

W3CDY sez:

W3DIU, Frank, has been putting up some stiff competition, for the boys in archery, to come out on top. He also has a rig on 2 1/2 meters.

W3DJZ, Hop, had an \$52 on 2 1/2 but gave it up, when he acquired some more, to put them on 75. Hop had a pleasant surprise when a W2 with mobile equipment on 2 1/2 passed thru Harrisburg, Pa. A contact was made & a pleasant visit resulted.

W3IGP & the gang went on F.D. with W3IEG, W3DPK & W3CDY. The results were fb for the time spent on the air but too much time was lost due to trouble with the power supply. Much was learned & we were sure glad to compete with the rest of the boys. We used a signal shifter and a xtal rig with low power on 40 & 80.

W3HFZ & W3HOV have had a fb time wrking portable 2 1/2 from Mt. Penn near Reading, Penna. Many 3rd district & some 2nd & 8th district stns were hrd besides the ones they wrked.

The activity on 2 1/2 has been growing around Harrisburg, Pa. & looks quite favorable for some new points for relay work during contests. The gang around Lebanon, Pa., is looking forward to getting on 2 1/2.

The boys seem to be looking forward to the coming Ham Fest to be held at Selingsgrove & from the look of things it is bound to be a success.

If you ever contact W3ENT there is a surprise in store for you if you can induce him to tell you his altitude. He may be small but he is a swell guy.

W3CXE has up a new sky wire & that may bring him on the air more frequently. At least we hope so.

W3FVQ has had fb results wid low power on 75 & likes it vvy much.

AND from the sage of Highwood, W9BZT:

W2LPR, Al, persists in poking his "Ole Signal" out here from back in Long Island. We can sure read you, Fella. He also got thru to W7HEY in Midwest, Wyo., and to W6AEP in North Hollywood, Cal. Really nice going, Al. Ken, W7HEY, counters wid a 5 7 Plus in Maitland, Fla., so maybe honors are even.

W6SPP, John, turns up in Fallon, Nevada, and we were able to pick him up here in darn nice style.

W4FB, Aaron, of good ole Birmingham, Ala., is still on 160 but not as active as of yore.

W5HSH, Huck, Shreveport, La., together with Eric, W5FCD, of Port Arthur, Texas, were just a rolling in the other A.M. They make a very fine QSO, interesting.

W9NOU, Florey, has left Elgin for Crystal Lake, Ill. Yep, got promoted, a raise 'n everything. No more pole climbin' says Florey, keeping swivel chairs shiny now. Congrats, Fella.

W5DPK, Bob, of Dundee, Miss., sure did a swell job of coming thru the heavy static of the last few weeks and his talk was well worth listening to. Very Nice, Bob.

W8Essa-Jay-exa of Erie, Penn., Eye-Ay, uses the foregoing to sound out his call then adds "Just a California Kilowatt" is the handle. Jack left 160 for 75 but I'll bet he'll be back.

W9DC, Walt, of Green Bay, Wisc., has put in his appearance on 160 finally and uses a Home Crown Sig Shifter what really shifts her around. Welcome Walt.

W90LM, Herbie, La Salle, Ill., is sure a hard guy to find—awake. Several visits produced nothing but blanks. He is on the air from midnite on, asleep until time to go to work and back on the air after work, but by golly when and which Herbie, Hi!

W9NOO, Gene, Ogleby, Ill., had no room for an antenna so sold his HRO. Betcha he gets another one shortly. How about it, Gene?

W9ZEN, Jennie, also of Ogleby, is kinda laying down on the job lately. Come on, Fella, we miss you, get back on.

The Society of Radio Operators and most of the North and Northwest side radio clubs of Chicago are co-operating in sponsoring an Amateur Round-up at the H Bar H Dude Ranch, on Milwaukee Ave., just north of Wheeling, which promises to be something different in the way of Ham-Fests. As planned thus far all profits will be returned, to the Hams attending, in the form of prizes and the YL's, XYL's and Kiddies will receive particular consideration. Should be a lot of fun and furnish some interesting material. More on this later.

W9GUE, Harold, and a few more Hams from Green Bay decided to hold a get together and before you could say scat, most of the Hams of Northern and Central Wisc., were "in" making it a grand party.

W9VEF, Paul, has left Chicago for the suburbs and is now toiling the merits of Wilmette, Ill. Co-operating with the local Chamber of Commerce, Paul?

W9IR, Bond, Chicago, is now piloting the Society of Radio Ops' Club thru this year as their hard working and well liked Pres.

For the Record
(Continued from page 4)

A complete analysis of the article by Mr. Riis has been made by an outstanding contributor to RADIO NEWS, Mr. John Rider. It looks as though the "top" is about to blow off the powder keg, and we urge every radio service man to read what this author has to say in defense of the radio man. Don't miss "As I See It."

We have long known that the radio service business, in general, could stand a great deal of improvement as far as financial income is concerned. The question has always been *how to make more money* legitimately and still be able to meet competition from the larger service organizations. It seems to us that much could be done to improve the present conditions. Hundreds of towns and cities in these United States include approximately five or six servicemen to handle the complete radio service for the community. Many of these men have been drafted, or have volunteered and are now in the armed forces. This has reduced the available servicemen who, for the most part, lacked the proper equipment to speed up their work in order to handle more customers.

By charging an additional 25c per call, it would be possible for the serviceman to accumulate the necessary funds required for the purchase of up-to-date test equipment. This could be done by maintaining a "kitty" at the service shop in the form of a can or other receptacle. Each time the serviceman returns from a call he would deposit the 25c therein and it would not be long before the full amount were accumulated.

The next problem deals with service fees. We believe that the 50c service call should be completely eliminated as it certainly does not permit the service-dealer to operate at a profit. This bugaboo can be best dealt with by a friendly get-together with competitive servicemen and by *establishing a minimum service rate*. Furthermore, it is possible to employ considerable financial savings by entering into a partnership arrangement with competitive servicemen. Much time could be saved by such a partnership if, say, three or four servicemen got together and formed an efficient organization whereby one man would specialize in r.f. circuits, another to handle audio trouble-shooting, and the third to act as store salesman and bench worker. The saving in overhead alone would be added income for each man.

There are other advantages to such an arrangement and they include the pooling of available replacement parts and equipment, which adds further to the effectiveness of the system by saving a lot of steps which were formerly required in shopping around for certain parts in order to complete the work on a receiver. Other savings would include telephone, advertising, etc. Some servicemen may disagree with this theory, and we should like to have their opinions.

A week seldom goes by that we don't receive a letter from a reader asking what the symbol "30" means as it appears at the end of the article. A very complete explanation was given in a

recent *F. C. C.* release. It might be explained that "30" is a term traditionally used by telegraphers. It means 'That is all,' 'The end,' or, in this particular case, 'Good Night.'

It is said to have originated in the following manner, according to the F.C.C.: "In the early days of news reporting, Washington correspondents wrote by longhand, and their copy was transmitted by telegraph. Operators at the receiving end had to make as many as a dozen copies of each dispatch. To mark the end of an item, they adopted the symbols XXX. Since three X's constitute the Roman Numerals for 30, this practice was not only popularized by telegraphers but by copy desk men as well. By the same token, the following numerals have special significance to old-time telegraphers: '4' (Where?); '8' (Wait); '13' (Understood); '19' (Railroad Order); '31' (Other order); '73' (Best regards); and '22' (Kisses)."—*Editor's note: Radio amateurs use "88" for "love and kisses."*

This month's issue of RADIO NEWS includes Part 1 of an article dealing with ultra high frequencies used in aviation air defense, written by an outstanding author. This article should be read by all who are interested in the newest applications of the "ultra-highs."

Radio amateurs will find a host of information in the article "Ultra Modern Transmitter Design," which appears in this issue. It features the design of a commercially available transmitter, which is constructed entirely of standard parts. Many of the features included may be added to existing radio transmitters. It is a "must" for the amateur radio operator.

The new series of articles dealing with "recording" makes its first appearance this month. This series will form a basic "handbook" for the recordist, and will include both theory and practice of both home and semi-professional recording equipment.

Ray Frank, W9JU, describes his latest "portable all-wave radio" designed around a commercially available tuning assembly, it will appeal to those who are interested in improving upon their emergency radio gear.

A tremendous amount of schooling is now being done by Uncle Sam and scattered around the United States are numerous radio training centers. One of the largest of these is *Scott Field*, where new radio operators are turned out at a mass production rate. Amateurs entering the armed forces should by all means make every effort to get into one of the radio schools and to receive the training Uncle Sam is offering.

Servicemen will be impressed by the inexpensive "Channel Substitute" which is featured this month. Parts for its construction will be found in almost any service shop and they need not be new.

The Public Address man will find the "Beginner's 14 W. Amplifier" especially intriguing since it may be constructed inexpensively and features several outstanding improvements in circuit design.

Last month we published a story of a trip to Grand Island, Nebraska, for ARRL Emergency Field Day. Mention was made of the total number of states worked, and the figure was given as "6" when it should have been "26" states worked. This was especially embarrassing inasmuch as *Ye Ed* was one of the members of the expedition. Our apologies to W9NLP and W9QEA for belittling our true score!

Well, another month has now passed and we anticipate some outstanding radio developments in the very near future. Uncle Sam is installing a network similar to the British Radiolocator and, if we don't miss our guess, it will be manned largely by the radio amateur. We are planning a trip to nearby training centers and next month will present a synopsis of the latest developments as we have learned them first hand. 73 OR

RADIO EVERYTHING IN RADIO

This one big book serves your entire radio needs. It includes sets, parts and supplies, public address systems, amateur equipment, testers, kits and fluorescent lighting. You'll find the nationally known favorites at the lowest possible prices. Get your copy of this big FREE CATALOG today

BURSTEIN-APPLEBEE COMPANY
1012-14 McGEE STREET, KANSAS CITY, MISSOURI

SOUND ENGINEERS!
Here's P.A. that Sells!

You can go to town with Sound when the equipment you feature is Lafayette. Here's quality P.A. for every purpose priced for every purse. Backed by twenty years of Sound engineering, the low-cost Lafayette line for 1941 is the year's outstanding money-maker. With new, advanced features not found in any other P.A. equipment, modern streamlining and remarkable tone fidelity, Lafayette's the P.A. buy for best results—in performance and in profit! Whether you use Sound equipment or sell it, it will pay you to investigate all that Lafayette offers. Send for full details.

LAFAYETTE'S FREE CATALOG
will help you select the sound equipment best suited to your needs, give you an idea of the completeness of this line and Lafayette money-saving prices. Mail the coupon for your FREE copy today.

Lafayette SOUND SYSTEMS

NEW YORK, N. Y. 100 Sixth Ave.
CHICAGO, ILL. 901 W. Jackson Blvd.
ATLANTA, GA. 215 Peachtree Street
BOSTON, MASS. BRONX, N. Y.
NEWARK, N. J. JAMAICA, L. I.

LAFAYETTE RADIO CORP.
Dept. 2J1 —100 Sixth Ave., New York, N. Y.
or 901 W. Jackson Blvd., Chicago, Ill.
Rush FREE Catalog.

NAME
ADDRESS
CITY STATE

RADIO made EASY

LEARN AT HOME - IN SPARE TIME!

36 VOLUMES in 1 Big Book!

1. Broadcasting System
2. Sound Speech Music
3. Electron Theory; Electric Current
4. Elec. Units; Ohm's Law
5. Electric Circuits; Batteries
6. Magnetism
7. Electromagnetism
8. Electromagnetic Induction
9. Inductance
10. Capacitance; Condensers
11. A.C. Circuits
12. Filters
13. Measuring Instruments
14. Radio Waves
15. Broadcasting Principles
16. Receiving
17. Vacuum Tube Principles
18. V. T. Characteristics
19. Vacuum Tube Construction
20. V. T. Detector and Amplifier Action
21. Radio Frequency A.M. Modulation
22. "Superheterodyne"
23. R.F. Amplifiers; Tuning Coils
24. Audio Amplifiers
25. Loudspeakers
26. Battery Receivers
27. Power-Supply Units
28. Electric Relays
29. Auto and Aircraft Radio
30. Phone Pick-ups; Public Address
31. Short-Waves
32. Photoelectric Cells; Cathode-Ray
33. Television
34. Antennas and Grounds
35. Testing; Servicing
36. Sound Pictures

Ghirardi's COMPLETE Course will train you QUICKLY

Here's your BIG CHANCE to get a thorough training in basic RADIO FUNDAMENTALS—quickly, easily. There are BIG OPPORTUNITIES and lots more jobs for men with radio training—in radio factories, in radio service shops—and in all branches of the Army and Navy.

RADIO, SOUND, TELEVISION —MADE EASY AS A. B. C.

Ghirardi's famous RADIO PHYSICS COURSE is the cheapest, quickest radio training you can find. The whole science of Radio, Sound, & Television in a form completely intelligible even to beginners without any previous radio experience. Clear explanations and 856 self-testing Review Questions make it as easy to understand as a primer. Thousands of successful radio men got their start with this book, and it's used by more radio schools and students than any other radio text in the world! Get this whole 972-page course today for only \$4—and get started on your own radio career!

Use It 5 Days —OUR RISK!

Your money is not fully satisfied. Don't delay—get started now—mail this coupon at once!

972 Pages 508 Illus.

\$4

Only 4

CLIP OUT — AND MAIL!

Radio & Tech. Publ. Co., Dept. RN-91, 45 Astor Pl., N. Y.
 Enclosed find \$4 (\$4.50 foreign) for my copy of "RADIO PHYSICS COURSE," with your 5-day Money-Back Guarantee.
 Name
 Address
 City State



LEARN CODE

the way you'll be using it by SOUND



The best way to learn to read code is by listening to code. The best way to learn to send code is by hearing your own sending repeated back to you. With the new All-Electric Master Teleplex Code Teaching Machine, you learn code

the natural, easy, fascinating way. Only instrument ever produced which records your sending in visible dots and dashes—then SENDS BACK your own key work at any speed you desire. That's why practically every school teaching code uses TELEPLEX. We furnish complete course, lend you All-Electric Master Teleplex, give you personal instruction with a MONEY-BACK GUARANTEE—All at a surprisingly low cost per month. Write today for FREE catalog RN 8. No obligation.

TELEPLEX CO., 107 HUDSON ST. JERSEY CITY, N. J.

RADIO TECHNOLOGY



RCA Institutes offer an intensive course of high standard embracing all phases of Radio and Television. Practical training with modern equipment at New York and Chicago schools. Also specialized courses in Aviation Communications, Radio Servicing and Commercial Operating. For Free Catalog Write Dept. RN-41.

RCA INSTITUTES, Inc.

A Radio Corporation of America Service
 75 Varick St., New York 1154 Merchandise Mart, Chicago

SOLAR RED-CAPS
 Smaller Diameter Dry Electrolytics

SPEED Servicing

Write for Catalog

SOLAR MFG. CORP. Bayonne, New Jersey

SERVICEMEN'S CASE HISTORIES

by **ALFRED A. GHIRARDI**

Reprinted from new 2nd revised edition of the **RADIO Trouble Shooters Handbook**. Copyright, 1941. Radio & Technical Publishing Co. Copyright in Canada and Great Britain, and all countries subscribing to the Berne Convention, by Radio & Technical Publishing Co. All rights reserved.

EMERSON D131, D136, D138, D139, D110, D112—(Chassis D)
 Noise 1) replace condenser out of which wax has melted. Separate the bleeder resistor from this condenser so the heat radiated from the resistor will not damage the replacement unit
 Changes for... 1) in receivers bearing serial numbers below 850,000 connect a 15,000-ohm 1/4-watt resistor from the tap on the volume control to ground

FARNSWORTH P-2 Record Changer
 Tone arm does... 1) check for loose lever contact always land necking tone arm to tone arm in same spot
 Trips erratically 1) see that trip finger does not interfere with release trip lever
 2) check for excessive binding in friction trip assembly

FADA F-55
 High-pitched whistle... 1) install a grounded tube shield around the 12Q7GT tube
 2) dress speaker leads away from 12Q7GT tube
 3) shield grid lead of 12Q7GT if necessary, and ground the shield

GENERAL ELECTRIC A-63
 Inoperative... 1) check for "shorted" 0.05-mfd. condenser by-passing 6A8 plate supply. Replace with 800-volt condenser. Also check 6,000-ohm resistor in this same circuit for possible damage
 2) replace 0.02-mfd. condenser connected between 6F5 and 6F6 tubes

GENERAL ELECTRIC G-65
 Whistling or squealing, Distortion... 1) move 0.012-mfd. condenser (connected from plate of 6K6G tube) further away from automatic tuning lead to reduce feedback

GENERAL ELECTRIC J-718, J-728, J-808, J-809, J-818, J-828

Irregularity of record changer... 1) for any irregularity of operation of the automatic record changer, check the adjustment of main lever No. 15 as follows:

- A. Main Lever.—This lever is basically important in that it interlinks the various individual mechanisms which control needle landing, tripping, record separation etc. One adjustment is provided for the main lever. Rotate the turntable until the changer is out-of-cycle; and adjust rubber bumper bracket so that the roller clears the nose of the cam plate by 1/16 inch
- Needle does not "track" after landing... 1) friction clutch adjustment screw may be too tight
 2) tone arm vertical bearing "binding"
 3) pick-up output cable twisted

GRUNOW 12W
 Inoperative... 1) check for "shorted" 0.1-mfd. by-pass condenser connected from third i-f transformer plate return to ground. Also check 2,200-ohm voltage dropping resistor in series with second i-f tube plate circuit for damage due to overheating

GULBRANSEN 872
 Distortion... 1) check for "leaky" condenser C-7 connected in plate circuit of second detector (from junction of resistors R-5 and R-6 to ground)
HALLICRAFTERS SX-16, SX-17 Super Skyriders Oscillator... 1) replace bakelite molded fixed trimmer condensers connected across oscillator coils—using new silvered mica type units for replacement

HOWARD 200
 Inoperative... 1) check for "shorted" 0.1-mfd. 200-volt condenser from 6K7 screen to chassis

HOWARD 518 Series
 Hum... 1) add an 8-mfd. 450-volt filter condenser across input of filter

HUDSON (STEWART-WARNER) DE-10, SA-10 Auto Radios

Hum... 1) check for "ground" inside of lower end of volume control in the control head (in addi-

tion to the ground which is made in the lower radio unit). Remove this accidental ground in the control head

LAFAYETTE 7G Series
 Buzzing noise... 1) "open" sensitivity control (dual unit with volume control)

MAJESTIC 230
 Weak reception... 1) "open" 500-ohm 1/10-watt resistor in grid circuit of 24 detector tube (connected from grid-return lead of tuning coil to ground). This resistor is located inside of coil shield, alongside the coil. Replace

MIDWEST 17-39
 Weak reception... 1) "shorted" 0.1-mfd. 400-volt audio coupling condenser. Replace with 0.02-mfd. 800-volt units
 Distortion (accompanied by red glow on plates of 6J5G driver tubes)

MOTOROLA 89K1 (Clock Tuning)
 Fails to turn on... 1) replay spring too stiff
 Turns on, but intermittently fails to tune when buttons are pushed
 Poor switch... 1) main motor switch must make positive contact when latch gate is pulled down by latch bar and the latch bar reversing switch must reverse positively when the latch bar falls to the low side of the latch ring. Clean contacts with Carbona. If necessary adjust as per instructions in service notes

OLDSMOBILE 982006
 Intermittent fading, Squealing... 1) solder piece of flexible bonding braid between ground terminal of volume control and chassis

PHILCO 40 (DC)
 Inoperative... 1) "open" speaker and tube socket contacts
 2) "shorted" section in condenser No. 12, 25 or 38
 3) "shorted" condenser No. 17 or No. 21
 4) "open" primary in input transformer No. 33 and output transformer No. 31

Distortion at high volume... 1) "shorted" condenser No. 24
 Weak "tinny" signal... 2) "shorted" primary in input transformer No. 33 and output transformer No. 31 (indicated by "frying" noise)

PHILCO 71
 Noise... 1) loose shields over oscillator and r-f transformers. Solder at rivets
 Distortion at high volume... 1) "shorted" condenser No. 21
 Weak "tinny" signal... 2) "shorted" condenser No. 38
 Hum... 1) clip dummy lug from condenser No. 38 and move wiring away from the adjacent condensers as far as possible

RCA U-10, U-12, U-11
 Intermittent reproduction on phono... 1) bent "pickup-shorting" switch on underside of changer
 Gear noise in record changer... 1) apply small amount of heavy fibrous gear grease (such as "Texaco Crater Compound No. 2") to spindle pinion and main gear teeth. Do not get this grease near, or into, spindle bearing. Apply the grease while the gear is in motion

RCA U-16
 Fading... 1) "open" or "leaky" 0.0025-mfd. condenser C-31 connected from "high" end of volume control to accessory tone control switch
 To increase response in Early-run receivers... 1) replace 82,000-ohm resistor R-11 with a 56,000-ohm unit (Stock No. 12286). Replace the 0.035-mfd. condenser C-33 with a 0.01-mfd. unit. Replace the 0.05-mfd. condenser C-51 with one of 0.025-mfd.

RCA 86K
 Interference in the form of heterodyne "beats," image response, etc.

RCA 86K
 Interference... 1) close the link on the antenna terminal board so it connects with the "A" terminal

(To be continued)

U. H. F. in Aviation

(Continued from page 8)

quencies are best for night or day operation, year around operation, etc., and the average "distance consistency" for each band. As in the lower or medium frequency bands, certain bands in the UHF (aviation) allocations exhibit definite and desirable characteristics for certain purposes; this being the reason for the band assignments as given above.

The effective communications range of the ultra high frequencies is said to be governed by the following factors: position of receiving station's antenna with respect to the transmitting station's antenna; power output of transmitter in watts; terrain obstructions in path of transmitted waves; type and height of antenna employed at both receiving and transmitting stations; type of ground antenna is installed upon, or type of aircraft; type of polarization employed, i.e., vertical or horizontal.

Taking the above factors into consideration in the order named, separately: In order to realize maximum efficiency from a UHF communications setup, whether fixed or mobile, the relation that the receiving antenna bears to the transmitting antenna with respect to directivity and polarization must be taken into consideration. As we are dealing with the aviation communications setup, we must necessarily consider wave transmission and reception from aircraft to ground and vice versa, the radio range system, marker beacon reception, "blind" landing aids, etc., and whether or not general coverage or directivity is to be desired.

In the case involving aircraft to ground communications, such as is used at airports, route cross-country contact stations (CAA) located on the airlines, etc., general coverage—that is, consistent communication within specified radii, (usually 50 miles maximum) without marked directional characteristics—is always desired. This necessitates the use of an antenna system which will afford general coverage with a minimum of directional effect. We will discuss this later.

The radio range system requires defined directional characteristics. It is necessary that an antenna array be used which will concentrate two or four course beams of known width in known angular directions from the transmitting station. Horizontal polarization is used because site requirements are much less severe than with vertically polarized transmission, and because multiple course phenomena is less prevalent than when vertically polarized transmission is employed. (Multiple course phenomena: Undesirable distorted beams either too wide or "parasitic beams" radiating in the wrong direction. These are caused by

reflection or improper antennae adjustment and improper wave phasing.)

Effective marker beacon (fan type marker) operation is dependent upon the following: A wave pattern must be projected from an antennae array and reflector system in a vertical direction perpendicular to the earth's surface and have a width sufficient for "over station" bearing at certain altitudes. Too, the strength of the projected wave must have sufficient intensity to actuate the receiving apparatus installed in the aircraft, at "workable" flight heights.

A complete four-element antenna system erected $\frac{3}{4}$ wavelength above ground, with the counterpoise being installed at a distance of $\frac{1}{4}$ wavelength below it was used by the CAA during first experiments to obtain correct wave pattern of the projected wave. A frequency of 75 mcs. being the frequency used for this marker beacon's "carrier" because it exhibited proper characteristics for the type of service desired.

The power output of the transmitter (in watts) governs the usable "working distance" to a very large degree. It stands to reason that with more power a greater distance will be covered by the waves, of course depending upon the angle of propagation, too, and a stronger signal will be received at the receiving station. Power requirements in the UHF spectrum however, are not as high as those in the lower or medium frequency portions of the radio spectrum.

Terrain obstructions—those objects such as towers, mountains, growth of vegetation, buildings, etc., all have attenuating influences upon UHF waves. In order to realize optimum results, it is necessary that no intervening obstructions of the order mentioned above be in the path of the transmitted wave. In the case of aircraft communicating with a UHF station located at the airport, with the aircraft flying near another metal aircraft of metal construction, noticeable signal intensity decreases will be experienced, depending upon the relative position of the "interfering" aircraft with respect to the receiving aircraft's antenna system. If an aircraft employing UHF communications equipment is flying in the vicinity of mountains, etc., and is so low that a "shadow" effect is created by the surrounding terrain, reception and transmission both are likely to be of a "low order." It is therefore necessary that the pilot or radio operator aboard the aircraft utilizing the equipment know the limitations of his equipment and know (from experience) the effects of various obstructions at various altitudes. It would be wise, too, to be familiar with the territory over which the aircraft is flying and be familiar with a few of the marked peculiarities affecting transmission and reception. When FM equipment is used, "shadow" effect when present tends to increase, rather than decrease the received signal. But when two

INTRODUCING A NEW TYPE OF MULTI-WAVE TUNER

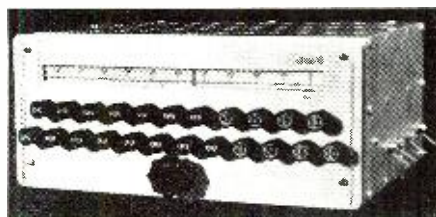

A COMPLETE FREQUENCY COVERAGE IN 23 STEPS

10 domestic broadcast stations—1700 kc. police band—160 meter amateur band—2400 kc. police band—80 meter amateur band—aircraft—49, 31, 25, 20, 19, 16, 13, 10 meter bands . . . and all this by means of push buttons. Guess work in short wave reception is eliminated in that this precision built product is capable of receiving short wave stations with the same facility as stations in the domestic broadcast band. No external variable condenser gang necessary; no gang switch used; no oscillator padding condensers; tuning is positive and smooth; mounted in dustproof metal cabinet; overall dimensions of tuner proper: $9\frac{1}{4}'' \times 6\frac{3}{4}'' \times 4\frac{1}{2}''$. Model 142 as illustrated above for superheterodyne circuit—465 kc. Wired and tested. Complete with instructions, circuit diagrams, charts and other useful data. Patents applied for.

\$15.60

Price WE PAY THE POSTAGE

Immediate Delivery Made Upon Receipt of Order

MICHIGAN RADIO PRODUCTS
LUDINGTON, MICHIGAN

FIX ANY RADIO

Amazing New Invention

Simplified
Radio
Servicing
by
Comparison
Method

Learn to repair radios in minutes instead of hours. Revolutionary, different Comparison technique permits you to do expert work almost immediately. Most repairs can be made without test equipment or with only volt-ohmmeter. Simple point-to-point, cross-reference, circuit suggestions locate faults instantly.

Complete
\$1
Training

FOR BEGINNERS OR EXPERTS

Find any radio fault with ease. Follow the comparison tests given on 16 large trouble-shooting blue-prints. Over 1,000 practical repair hints. Hundreds of simplified tests using a 5c resistor and a filter condenser. Covers every radio set—new and old. Introductory material for beginners and to serve as a review for experienced radio men. Also several chapters on test equipment. Presented in manual form, $8\frac{1}{2}'' \times 11$ inches. Entire plan is stark new and will change servicing methods. Protected by U.S. Copyright, but may be used by you for speeding up radio service work.

SATISFACTION GUARANTEED



Take advantage of our "no-risk" free trial. Use this time-saving money-making radio servicing method for 10 days without any obligations. See how much time you will save every day on every radio job. Learn new short-cuts in radio servicing. Then decide to keep Comparison Method Manual or return it and receive a refund in full. You cannot lose—but you owe yourself a chance to look at this plan.

NEW 1941 EDITION

The complete simplified training is yours for only \$1.00, full price. It will more than pay for itself on the first radio job. Examine and use this new plan for 10 days at our risk. Send "no-risk" order coupon right now. Use the plan this week.

NO-RISK ORDER COUPON

SUPREME PUBLICATIONS

3727 W. 13th St., CHICAGO, ILL.

Ship the new manual, "Simplified Radio Servicing by Comparison Method," for examination. I am enclosing \$1.00, the full price, and 10c for postage. I must be satisfied or you guarantee to refund my remittance.

Name.....RN-S-S
Address.....

★ ★ ★ ★ ★

UNCLE SAM NEEDS YOU!

★ LEARN CODE NOW ★

FUTURE DRAFTEES ATTENTION!
A rapid rise in rank along with a corresponding increase in pay is guaranteed you when you can qualify as a trained code operator in Uncle Sam's Communications Divisions.

BE ON YOUR TOES—get ahead of the other fellow—start learning code now by the easy, practical **CANDLER** way *right in your own home!*

DON'T DELAY—CLIP AND MAIL THIS COUPON NOW!

CANDLER SYSTEM COMPANY, Dept. N-9, Box 928, Denver, Colorado.

I am interested in preparing myself for the Army, Navy, or Commercial Communications field. Please rush me my FREE copy of the 52-page **BOOK OF FACTS**.

NAME.....ST. & NO.....

CITY.....STATE.....

★ ★ ★ ★ ★



NEW HAND SET—AIRCRAFT TYPE

... for mobile, pack transmitters, amateurs, aircraft, 2-way phone systems, etc. Dependable, long life, low price. Black Bakelite case with 8 ft. cord. Microphone and receiver terminated separately. Switch not available. Wt. complete only 7 oz., packed 1 lb. 75 ohms match line impedances; 2,000 ohms match plate circuit of output tube. Either resistance.

UNIVERSAL MICROPHONE CO. \$10.00
Ltd., Inglewood, Calif., U.S.A. List

RADIO COURSES

Start September

- RADIO OPERATING—BROADCASTING
- RADIO SERVICE—3 practical courses
- RADIO AMATEUR CODE ● TELEVISION
- ELECTRONICS—1 yr. day course, 2 yrs. eve. Day and Evening Classes. Booklet Upon Request.

New York Y. M. C. A. Schools
7 W. 63rd St. New York City

COMMERCIAL RADIO INSTITUTE

A radio training center for over twenty years. Well equipped. Excellent faculty. Practical resident courses in Radio Telegraphy, Broadcast, Servicing, Industrial, Television, Aeronautical, Drafting, Mathematics and Studio Technique. Placement Bureau. Fall term October 6. Catalog upon request.

Dept. C, 38 West Biddle St., Baltimore, Md.

RADIO-TELEVISION

Oldest, largest Radio-Television school in West trains you for good pay job. Complete instruction including Radio Construction and Service, Broadcast Operating, Sound, Talking Pictures, Television, Public Address, etc. Flexible plan to meet specific needs of those with or without jobs. Transportation allowed to L. A. Earn room and board while learning. Request Free Catalog.

NATIONAL SCHOOLS Dept. 9-RN Los Angeles

RADIO ENGINEERING DEGREE IN 2 YEARS

Intensive, specialized course, including strong basis in mathematics and electrical engineering, advanced Radio Theory and Design, Modern laboratory. Low tuition. Self-help opportunities. Also 2-year courses in Aeronautical, Chemical, Civil, Electrical and Mechanical Engineering. Participation in Civilian Pilot Training Program. Enter September 2, December, March, June. Catalog.

INDIANA TECHNICAL COLLEGE
791 E. Washington Blvd., Fort Wayne, Ind.

Correspondence Courses in RADIO and ELECTRICAL ENGINEERING

ELECTRICAL ENGINEERING Get good grasp of wide future. Modern course. So simplified anyone can understand quickly.
RADIO ENGINEERING Extra fine course in radio, public address, photo-electric work. Trains you to be super-service man, real vacuum-tube technician. Experimental kits furnished. Diplomas on completion.

Either course, only \$25. Deferred payment plan available. Write for free copies of school catalog, student magazines, full details.
LOW AS \$25
LINCOLN ENGINEERING SCHOOL, Box 931-R 33, LINCOLN, Nebr.

stations of the same frequency are operating simultaneously, a 2 to 1 signal ratio is needed for "signal control." That is, the stronger station should have a signal twice as strong as the other station on the same frequency in order for the "changeover" or "signal control" to take effect. This is sometimes undesirable in the case of aircraft communicating with a ground station. With the aircraft fly-away from the route-cross country contact station, and entering into a signal control zone, the nearest station will take over and communication will be lost with the desired station. If important travel information is being received and/or given, a delay would result until the first station relayed the intelligence to the second station.

It has been shown after exhaustive tests, that the type and height of antennae employed at both the UHF receiving and transmitting stations has much to do with reliable communication. When a vertical radiator is used at the transmitting station, it has been found that a vertical receiving antenna should be used at the transmitting station also. However, in nearly every case, the type of service required will usually dictate the type of antenna necessary for best results. An aircraft flying at altitudes above a fixed minimum will encounter better reception, depending upon the "ground wave component" of the transmitted wave. But it has been demonstrated that the higher the aircraft is, the better the reception and transmission, to a certain altitude. The "saturation altitude" (the point where the free-space wave and the wave reflected from the ground cancel) is noticed and reached when a decided drop in signal strength is perceptible.

The type of ground the airport antenna is installed upon and its height above ground is of the utmost importance, as is the type of aircraft (whether metal or fabric and wood construction) upon which the aircraft antenna is installed. Over-all antenna characteristics, insofar as reflection and consequent directivity are concerned, are controlled to a certain extent by ground and aircraft structure. This can be best understood, by thinking of the aircraft proper as a counterpoise and a reflector at the higher frequencies. Likewise, the type of ground, whether it is moist, dry, or mineralized, has an effect on the airport antenna's characteristics inasmuch as it provides a capacitive effect proportional to the distance between ground and antenna proper. Too, reflection must be considered, in that the antenna is usually mounted perpendicular to ground. When designing both the aircraft and airport antenna, it is necessary to consider the above.

Wave polarization, either vertical or horizontal, may be employed for aviation communications operations. However, whether one or the other is to be used depends upon the following: Allowable noise levels (lower with horizontal wave polarization); radii

to be covered (controlled by angle of transmitted wave; vertically polarized waves better for "close ground" work such as is employed by the police services); the type of antenna that may be employed taking mechanical and electrical construction details and space limitations into consideration; allowable height of the antenna, with reference to available mounting provisions; and the frequencies that are to be used.

FM vs AM for Aviation Communications

With the advent of frequency modulation, much thought was directed toward its employment in the aviation communication setups. After the many experts throughout the Nation had presented their findings, and after many papers had been written on the subject, it was concluded that, for the time being, FM did hold some decided advantages, but these were not so great as to warrant the disregard of AM altogether.

It was realized, however, that more stations could be accommodated on the available channels operating on the same frequencies with less interference by employing FM, but then the "signal control" considerations and effective coverage for the amount of power used, made the situation appear as though AM should be employed in preference to FM. It has been said by some engineers that for the same amount of power, FM has a 50% greater service area than AM, but actually, high fidelity seems to be the greatest retaining factor in favor of FM. High fidelity is not entirely necessary for aviation communication purposes; where, in some cases it is disregarded in favor of low fidelity with consistent communication, rather than high fidelity with sporadic communication. It is true that the noise in AM systems is practically negligible, but then, the noise considerations in AM systems operating on the ultra high frequencies are quite negligible, too, if the equipment is installed and maintained properly. FM may be employed for airport traffic control purposes, but as the situation now "rests," AM decidedly has the "light."

Antennae for the Ultra High Frequencies

There are many types of UHF antennae that may be readily adapted to aircraft installations. However, by basing our choice on experience and on the "cut and try" methods used by those who have had occasion to employ the various types for UHF usage aboard aircraft, we will make no attempt here to discuss every type. We will confine our discussion to the types used and recommended by those who have employed and found them worthy of consideration.

Antennae as employed for UHF transmission and reception are dimensionally much smaller than those used at the conventional frequencies; and those used for micro-wave transmission and reception are still smaller. It

should be remembered also, that those principles governing the design of the low and medium frequency antenna are still applicable to the UHF antennae, but certain factors not often thought of also enter into the design of the UHF antenna system.

In choosing an antenna for a particular service requirement for UHF transmission or reception, or both, these questions should be kept in mind: How small can the antenna actually be? How is the antenna located with regards to service accessibility? Does the antenna have a large amount of aerodynamic drag? Are mounting provisions incorporated in the aircraft for the antenna? How efficient is your particular design? What particular service must be rendered? (Whether general coverage; marker beacon reception; collaborative transmission and reception etc.) What type of transmission line may be employed, consistent with good mechanical as well as electrical design practice?

Answering these questions in order: The antenna can be as small as the frequency or frequencies used, allow, depending upon wavelength. Due to the fact that the UHF antenna can usually be made a "pure" resistance at the operating frequency without the aid of capacitive or inductive tuning elements, it is quite possible to make the antenna comparable in dimensions with the wavelength of the specific frequency used. This is the main reason why UHF antennae are of such "minute" dimensions as compared to those used on the low frequencies. Location accessibility is of prime importance. It is known that due to vibration any externally connected member of an aircraft will loosen in time. For this reason then, it is necessary to locate the antenna in such a position so as to afford the technician ease of access.

Aerodynamic drag (wind resistance or impediment to ease of air flow) of the antenna must be taken into consideration. With aeronautical engineers attempting to "streamline" modern aircraft to the "nth" degree, added, externally connected members or parts, such as rivets, masts, etc., somewhat defeat the purpose. The antenna should always be installed in such a position so as to offer the least amount of drag. This would mean then, that the smallest antenna (having the smallest surface) should be used.

In mounting the aircraft antenna, provisions are usually made by the aircraft manufacturer (after consultation with the aviation radio engineer and his engineering staff) at the factory for its attachment to the aircraft proper. However, there are so many designs of antenna that it is generally a rule to let the aircraft radio manufacturer worry about mounting provisions; but recommendations are usually given as to the best possible "least drag" locations. Is the antenna that you have designed for a particular service efficient? In designing the antenna for a particular service, those factors influencing overall efficiency

should be computed over and over again in order to make certain that the highest efficiency is assured. It can be said that an antenna is available for every specific communications purpose.

An antenna designed to work well as a "general" coverage antenna may not work well when employed for receiving marker beacon signals. Too, an antenna used in collaborative transmission (used for both transmitter and receiver) may not operate well as a "general" coverage antenna. Each antenna must be designed with a particular service requirement in mind. This is *very true* when ultra high frequencies are used. The type of transmission line that may be employed is governed by the type of antenna used, its loading characteristics, frequencies used, and output and input characteristics of both the receiver and the transmitter. The latter coming (usually) under "loading characteristics."

It has been found that the best antenna thus far for straight "general" coverage when the ultra high frequencies are employed for aircraft to ground contacts and vice versa, is usually a half wave vertical rod. This antenna is to be preferred to the horizontal types which exhibit directional tendencies. It is economical, stands up well under constant vibration, and offers less aerodynamic drag, than do the horizontal (mounted transversely on the belly or between wings), trailing or "free" wire types.

Upon mentioning the trailing wire antenna, those who have worked with them in the medium or low frequency bands aboard aircraft will shudder at this writer's "incompetence." But a "trailing wire antenna" is entirely practicable for UHF usage as will be shown later.

Marker beacon receivers operating at 75 mcs. are usually provided a balanced "split wire" or doublet antenna cut to frequency, usually 6 feet 6 inches in length. However, a balanced "T" or a horizontal di-pole may be used depending upon the type of aircraft.

The absolute altimeter employs a "micro-wave" antenna. This antenna resembles the stub mast usually found on the rudder of a large aircraft to which is usually attached a long antenna for medium frequency transmission and reception. It is a di-pole and resembles two pipes fastened end to end, but with one "pipe" smaller in diameter than the other. It is fastened out underneath the wing of the aircraft and its mounting "mast" makes the assembly resemble an inverted T.

For aircraft service, (for the frequencies used for general contact work) the receiving antenna should be non-directional and at least $\frac{1}{2}$ wavelength long, the mechanical length measured in inches being governed by the frequencies received. An arbitrary length should be adopted for a stipulated channel coverage. That is, within certain limits. If the band of frequencies 129-132 mcs. must be covered, then the length should be such that



Buy your SX-28 from Bob Henry . .

Why keep your old receiver when you can get the best trade-in value from me on a Hallicrafters New SX-28. Here is a communications receiver that has everything—15 tubes, 6 bands cover from 550 kc. to 42 mc. with all the latest 1941 features for better communications reception. Drop me a line here at Butler for a free estimate on your trade-in. Easy 6% terms are financed by me to save you money! You can have your choice from the world's largest stock.



Write to me today!

Bob Henry

W9ARA

HENRY RADIO SHOP

BUTLER, MISSOURI

World's Largest Distributor of Amateur Receivers

**Have You Lost
Your Chance
in Radio?**

• CREI Home Study Training is helping more than 5,000 professional radiomen toward a more secure future in Radio and better-paying radio jobs!

Many radiomen are willing to "drift with the current" . . . to fight for their jobs when business is bad . . . to hope for a better one when business is good. But the ambitious man knows that when he is equipped with modern technical training he is insuring his future in radio for all time—he isn't depending on "hope."

Right now—there are good-paying jobs in radio waiting for qualified men to fill them. Right now—is the time to train for not only these better jobs, but for a secure place in an industry that recognizes ability and rewards it with good pay. NOW is the time for YOU to act—to find out how CREI can help you get ahead and STAY AHEAD!

WRITE FOR FACTS TODAY!

Our free booklet and personal recommendations may hold the answer to your future success. In your inquiry please state briefly your background, education, present position—and whether interested in Home Study or Residence School training.



**CAPITOL RADIO
ENGINEERING INSTITUTE**

Dept. RN-9, 3224 16th St., N. W., Wash., D. C.

it will have somewhat of a high "Q" at both the highest and lowest frequency. This is accomplished by making the antenna length compromise with the lowest frequency and providing the necessary tuning elements for the highest frequency.

It is quite possible to utilize one antenna for both transmitting and receiving UHF, but then a method to switch the "common" antenna between both the receiver and the transmitter must be evolved, with resultant losses in efficiency due to the added capacity, etc., of the switching device. This is not recommended, but can be employed if the transmission lines are kept as short as possible, and within limits of "common" impedance for proper matching, and if a switching device (relay) is obtainable that employs low contact capacity points, etc., but still a certain amount of loss will be inherently prevalent.

In nearly all UHF aircraft radio installations, coaxial cable will be found as the "carrier media" for both the incoming and outgoing signals. There is little reflection (end) when it is used for carrying the transmitted signal, and very few standing waves will prevail. If feed lines of the open ended, untuned type are used (usually are for UHF), small spacing between lines should prevail and care should be taken with feeder balance. Above all,

the characteristic impedance of the line should match the effective resistance of the line termination. That is, where the lines connect to the load; the antenna.

Wave reflections will be held at a minimum if correct termination is accomplished, and it will be found that higher efficiency will prevail. However, in order to accomplish correct line termination it is necessary to cut the lines for proper "feeder characteristics" and proper "Q." The latter being highly important in the UHF systems. Correct spacing should be affected, but sometimes one drawback presents itself, i.e., that of mounting provisions for the equipment which will place the receiver and transmitter at distances within reach of the properly spaced-cut line. A compromise must sometimes be made between operational efficiency and set location when transmission line characteristics must be taken into consideration.

Lead-in connections should be as short as space and installation circumstances allow, and as electrical characteristics dictate. Insulators having high insulating qualities should be employed and where added capacity effects are introduced by the use of such insulators due to coupling screws, etc., a more direct means of connection should be found, such as employing high insulated, protected wall, tubing that may be readily inserted and clamped into position externally by utilizing fibre clamps. The transmission line (if coaxial is not used) is then run thru the tubing and connected to the internally installed equipment.

In suspending transmission lines, coaxial cable etc., from the structure inside the aircraft, standoff insulators should be used as often as is consistent with proper installation standards, taking "bulk weight" into consideration. Enough slack should be left in the transmission lines to allow for "carried vibration" at both the receiver and the transmitter or coupling units. The reason is obvious.

It is quite possible to use an antenna trailed out of the aircraft on its own transmission line. The antenna would consist of a rod cut to frequency and weighted properly so that it would not act as a pendulum at various cruising speeds. It will swing, but the distance of travel will not be great if weighted properly. This antenna could not be used under severe icing conditions but is fine for use with portable sets, that may be used in both the aircraft and the ground station.

The suspension of a vertical antenna (down dropped) from a horizontal antenna is not recommended. However, in order to alleviate directional characteristics due to all-metal plane construction in some cases, a vertical antenna may be suspended from the center of one side of a "V" suspension system. A good strong, non-conductive weather proof material, such as treated "shroud line" would be strung from one wing tip to the other wing tip, the tripod being at the center or

top of the rudder. Depending on which side is nearest to the installed receiver and/or transmitter, the vertical antenna would be suspended so that minimum wind resistance would be encountered and the coupling unit (if used) would have to be placed near the units with the greater part of the transmission line connecting the vertical antenna to the units proper or to the coupling unit. This method can be used, depending upon installation requirements.

At ultra high frequencies, especially when a large mass body of metal lies within the vicinity of the transmitting or receiving antenna, directivity is inherently present, present whether or not a horizontal or vertical antenna is utilized, but less with the latter.

When the CAA conducted tests with the 125 mc. airport traffic control and aircraft equipment sometime ago, it was found that their 1½ foot vertical rod antenna erected above the fuselage in the Bureau airplane NS-62, exhibited directional characteristics, being particularly effective over both wings and slightly less to the rear. It was believed at that time, that this directivity was in the main, due to reflection effects from the four foot standard radio range (low frequency) antenna mast located a few feet behind the 125 mc. rod antenna.

In avoiding directional characteristics when installing the antenna, both transmitting and receiving, it should be remembered, that mass metal reflection, or reflection due to externally installed structures causes undesirable directional qualities, and the antenna should be placed as far away from the main metal mass as is consistent with good mounting. It has been illustrated, that by using a vertical antenna placed either directly underneath the nose of the aircraft or midway between the tail section and juncture of the wing or wings, that a large amount of the directivity encountered will be eliminated. Also, it is possible to install the antenna underneath the part of the wing nearest the receiver and transmitter, but in every case if other antennae used with low or medium frequency apparatus is installed, the UHF antenna should be as far away from these as possible.

A method to determine the best possible position of the UHF antenna with respect to directivity caused by mass metal reflection and externally connected structure on aircraft similar to the *DC-2 Douglas Transport*, was worked out sometime ago by the author. By employing a vertical antenna with the standard isolantite base to which a suction cup mounting was attached, and using a transmission line matched properly to the receiver and transmitter components with a length permitting wing and fuselage coverage with the test antenna; the approximate directional characteristics could be partially determined and a suitable site found for the antenna installation.

The aircraft was located some distance from the transmitting station

Classified

Rate 15c per word. Minimum, 10 words.

CORRESPONDENCE COURSES

AMATEUR Radio licenses, training in code and theory. Resident and home study courses. Hundreds of licensed students. American Radio Institute, 1123 Broadway, New York.

USED Correspondence Courses and Educational Books sold or rented. Inexpensive. Money-back guarantee. Write for Free Catalog listing 4000 bargains. (Courses Bought.) Lee Mountain, Pisgah, Alabama.

CORRESPONDENCE courses and educational books, slightly used. Sold. Rented. Exchanged. All subjects. Satisfaction guaranteed. Cash paid for used courses. Complete details and bargain catalog free. Nelson Company, 500 Sherman, Dept. J-237, Chicago.

PATENT ATTORNEYS

PATENTS—Advice and booklet free. Highest references. Best results. Promptness assured. Watson E. Coleman, Patent Lawyer, 724 9th Street, Washington, D. C.

PATENT your idea—Simple inventions often valuable. Two advisory books—free. Victor J. Evans & Co., 429-K Victor Building, Washington, D. C.

INVENTORS—Before disclosing your invention to any one send for Form "Evidence of Conception"; "Schedule of Government and Attorneys' Fees" and instructions. Sent free. Lancaster, Allwine & Rommel, 414 Bowen Building, Washington, D. C.

PHOTO FINISHING

ROLLS DEVELOPED, two prints each and two free enlargement coupons, 25c, reprints, 2c each; 100 or more, 1c. Summers Studio, Unionville, Mo.

RADIO ENGINEERING

RADIO Engineering, broadcasting, aviation and police radio, servicing, marine and Morse telegraphy taught thoroughly. All expenses low. Catalog free. Dodge's Institute, Elm St., Valparaiso, Ind.

RADIO SUPPLIES

FOR SALE: RCA 150 Oscillator, 151 Oscillograph, Triplett Multitester, Rider's Manuals I-IX, etc. H. J. Hoxie, Worthington, Minn.

in a clear area (near landing field) where no obstructions were close enough to thwart the effectiveness of the tests. The test antenna was placed at different predetermined areas on the aircraft, and in each area, as the aircraft was turned through 360°, minimum and maximum recordings were made at 0°, 90°, 180°, 270°, and back to the first setting. A graph was drawn for the tests and where maximum signal indication for the four settings varied but little, the spot was marked and then considered as to its feasibility for antenna erection. The entire test would occupy the larger part of a day, but it was found that it more than paid for itself.

Flight tests (operating equipment) seem to be the best tests for antenna directivity because "ground factors" enter into calculations which sometimes do not prove correct; practical tests always prove to be the most effective because of the absence of so many "controlling" factors.

These points must be kept in mind when conducting a test as described above: There exists a certain amount of inherent capacitance between aircraft, ground, and antenna proper which will have an effect on the resultant readings, depending on how far the transmitting station is located from the aircraft. The height of the antenna above ground will also have an effect on the resultant readings, depending upon the method of wave polarization. Too, the dielectric constant of ground and the "variable ground conductivity" between the aircraft and the transmitting station will also enter into the calculations. These will present striking influences on the received and transmitted waves, especially if a vertical antenna is used.

These are major considerations, but an "average" for the lot may be readily computed if the approximate "counterpoise capacitance" (aircraft metal mass to antenna) is known. Although the test above takes directional properties into consideration as encountered on aircraft, it stands to reason that a separate "orientation" test must be conducted for determining the directional characteristics of both the receiving and transmitting antenna; or if one antenna is used, separate receiving and transmitting tests must be conducted with the ground station acting as the "recorder station" when the latter is in progress.

Before installing the UHF antenna it is necessary that the radio technician know what is to be expected from his installation. It would be advisable under all circumstances to study the aircraft radio manufacturer's instruction book provided with the equipment before proceeding with the installation. With experience gained from previous installations and with the aid of the manufacturer's instructions, a highly efficient installation will no doubt result.

The following are guiding points for UHF antenna installation on aircraft; the transmitting and receiving antenna

being given equal consideration.

If a "common" antenna is employed for both receiving and transmitting, make certain that the relay supplied by the manufacturer is properly adjusted prior to its installation; and do not attempt a "readjustment" if it does not operate properly upon installation, unless written instructions covering readjustment are available. Good insulators for the base mounting should be employed as stated elsewhere, and the actual transmission line connection to the antenna proper should be affected with "double-ribbed" clamps soldered to the antenna at the proper point. The soldered connection is covered with a good weather resistant material such as glyptal, spar varnish, shellac, etc., and just enough used for covering the joint properly.

Due to vibration ordinary clamps will not suffice for effecting connection, but the double-ribbed type obtained thru nearly any aircraft parts dealer (mentioned above) will take care of the job very well. Locate the antenna or antennae as far from other vertical antennae as possible in order to prevent, if possible, undesirable reflection and wave distortion. No UHF antennae should be installed near other low or medium frequency antennae (vertical or horizontal) or protruding metal members that may act as "parasitic radiators," likened unto those used by amateurs for their beam antennae because losses in efficiency will inevitably result. However, if the antenna is installed "atop" the fuselage and an underbelly antenna is employed for marker beacon reception etc., no undesirable effects will be usually noticed because of the distance separating the two.

In some instances, if the receiver and transmitter are installed in the tail section of the aircraft (as in some German aircraft) it is possible to mount the "common" antenna on top of the vertical stabilizer. This seems to be a very good site for the UHF antenna, but is not recommended when the equipment is installed some distance away resulting in long transmission lines. It is necessary, in nearly every case, for the technician to cut his own antenna if a telescope or fish-pole antenna is not used. Care should always be taken in measurement because herein lies success to high efficiency. When installing the marker beacon antenna for the 75 mc. band, and if a doublet antenna is used, the overall length as stated before should be approximately 6 feet 6 inches long for best results, with 39 inches of wire on each side of the center insulator or insulated mast.

If a dipole antenna is used, it should be remembered that the smaller the diameter of the elements, the greater reactance and greater impedance ranges encountered. The usual 1/2 wave di-pole has an impedance at the center of approximately 85 ohms. At resonance the di-pole is purely resistive and the impedance is less than 73 ohms.

SPRAYBERRY TRAINS YOU for GOOD PAY! STEADY WORK! ADVANCEMENT! in RADIO and TELEVISION



DON'T WAIT! START NOW!

You Can Make Money Almost At Once
You'll be quickly shown how to get and do neighborhood Radio Service jobs... for practice and profits. You easily learn Television, Frequency Modulation, Signal Tracing, Mobile Radio (Auto-Tank), Aviation Radio, Electronics, Facsimile Radio, Radio Set Repair and Installation Work. I'll Prepare You Quickly In Spare Time

SPRAYBERRY Training does not interfere with your present work. You will receive personal coaching service all the way. You'll be fitted to hold down a good paying job in Radio or to have a Radio business of your own.
You Get Professional Test Equipment
... Plus Experimental Outfits
... Includes 146 RADIO PARTS (to build complete Radio Receiver), RADIO TOOLS and a TESTER-ANALYZER. MY EXPERIMENTAL OUTFITS enable you to conduct actual experiments with your own hands.

NO EXPERIENCE NEEDED
It makes no difference what your education has been, I can fit you to become a real RADIO TECHNICIAN. Your success is my full responsibility.

THE SPRAYBERRY COURSE IS SOLD UNDER MONEY-BACK AGREEMENT

RUSH COUPON for BIG FREE BOOK

SPRAYBERRY ACADEMY OF RADIO
F. L. Sprayberry, President
425-J University Place, N. W.
Washington, D. C.

Please rush my FREE copy of "HOW TO MAKE MONEY IN RADIO."

Name..... Age.....

Address.....

City..... State.....
(Mail in envelope or paste coupon on penny postcard)

PUBLIC ADDRESS HEADQUARTERS



RADOLEK De Luxe Public Address Systems offer the most for your money in Styling—Hi-Fidelity Performance—Reserve Power—fast, convenient, easy installation. Offered in 15, 30, 50 and 100 watt sizes—for permanent, portable or mobile use. They feature from 2 to 6 input channels, built-in input and mixing controls, AVC, and the newly developed "feedback" tone control circuit. Wide choice of microphones and speakers. Mail coupon for complete information.

RADOLEK'S NEW 1941 RADIO PROFIT GUIDE

FREE! Indispensable to every serviceman, dealer and sound engineer. Send for big FREE Radolek Profit Guide now!

SEND TODAY! PASTE ON A PENNY POST CARD

RADOLEK CO., Dept. B-58
601 W. Randolph St., Chicago, Ill.
Please send information on Radolek Public Address equipment—also new 1941 Radio Profit Guide.

Name.....

Address.....

DEALER SERVICEMAN EXPERIMENTER



For that
"PRO"
 touch...

- Your transmitting "rig" takes on that "pro" or professional touch when you install these Aerovox Type -09 square-can Hyvol capacitors. Mount them upright or inverted, any height above or below chassis, by means of adjustable mounting bracket. Generous oil-impregnated oil-filled paper sections insure cool, safe, economical operation for years. Exclusive Hyvol oil insures satisfactory performance, even at freezing temperatures. An all-round professional job for "pro" grade equipment. Working voltages up to 5000 D.C.

ROUND-CAN...

There's also the -05 series in round aluminum cans with high-tension pillar terminals. Adjustable ring mounting. A quality capacitor at popular prices. Working voltages up to 3000 D. C. The Series -12 is available up to 7500 v.

SCREW-MOUNTING...

Similar to inverted screw-mounting aluminum-can electrolytics. Ideal for power-pack filter circuits. With screw-stud and lock-nut for one-hole inverted mounting. Working voltages up to 1500 D. C.

Ask Your Jobber...

- He'll gladly show you these Hyvol transmitting capacitors. Ask for latest catalog, and FREE subscription to Aerovox Research Worker. Or write us direct.



Twisted pair transmission line having the proper impedance is usually used for coupling the antenna to the marker receiver proper; and in some instances where it is found that more wire than is actually needed to affect proper matching is available, the excess is usually coiled up and suspended on a fibre frame held off the structure with a standoff insulator. Manufacturer's instructions will cover this. If concentric feeders are used, and the outer shields of these are grounded, make certain that uniform grounding is prevalent. That is, be certain that the shield is connected always to the lowest possible resistance joint. Contact noise will sometimes occur if the shield vibrates against metal members, for this reason, it should be taped and shellacked around bonding strips. It is generally known that the effectiveness of the antenna for receiver operation at the lower frequencies materially increases as the length of the antenna is increased, that is, away from the main body of the aircraft. But at ultra high frequencies, increasing the overall length of the antenna does not add appreciably to efficiency unless the increased length is commensurate with proper electrical length. For this reason, the aircraft antenna (whether transmitting or receiving) should be made either a quarter or half wavelength long. The latter being recommended.

Due to the thin metal construction found on most modern aircraft, it will sometimes be necessary to mount the base of the antenna on metal supports installed inside the aircraft (usually rib structure mounting). This will necessitate cutting a hole approximately 2 inches in diameter to accommodate the base insulator. In packing the hole after the antenna has been fastened to the metal supports, it will be necessary to utilize material having good insulating and weatherproofing properties. This is necessary in order that arcing be prevented if the base is at a high r.f. potential (depending upon type of "feed" and length of antenna) and also to prevent deterioration due to the elements. An isolantite insulator may be used for the "grommet" which is used to prevent water seepage into the aircraft.

UHF antennae for airport traffic control stations, etc., should receive as much consideration from the design and installation standpoints as does the aircraft antenna; because its characteristics somewhat parallel those found in the aircraft installation.

For general coverage (radii of 50 miles) we do not desire directional qualities, and in achieving this general coverage, correct antenna site determination is of paramount importance.

Due to metal hangars, power lines, in some instances, trees, etc., site determination presents major difficulties to the installation technician.

The 125 mc. airport traffic control setup at Indianapolis erected by the CAA utilized an antenna consisting of a vertical copper tube approximately

one-half wavelength long, fed by the transmitter by means of a 3/8 inch coaxial cable through a quarter wave open wire impedance matching transformer. The antenna and matching section had an overall length of 5 feet 3 inches and was installed on top of an iron pipe above the airport beacon light, about 50 feet above ground. The tests with this antenna indicated that it worked very well.

One test made during severe static conditions indicated that the UHF system in contrast to the low frequency radio range was better insofar as clarity, freedom from static disturbances, etc., were concerned. With the output of the UHF transmitter being in the neighborhood of 100 watts, as compared to the low frequency transmitter's 1000 watts, good reliable reception was had at a distance of 42 miles, where, at a distance of 15 miles from the transmitter, signals from the 1000 watt transmitter were obliterated by static. From this, it can be seen why UHF is being used and considered.

In determining the sight location for the UHF airport traffic control station's antennae, the terrain, distance and line of metal obstructions, etc., should be taken into consideration. The antenna should be placed as high as possible above ground, consistent with good mechanical and electrical installation practices.

It has been proven, after much research with available equipment, that the best antenna for the aviation radio ground station (airport traffic control etc.), operating on frequencies lying in the 128 to 144 mc. band, is a two-crossed dipole antenna properly phased with respect to each other so that a circular pattern horizontally polarized is transmitted.

Various manufacturers and engineers advocate other types of ground station antenna for use at the ultra high frequencies, but it is felt that the two crossed dipole gives more than the required amount of consistent general coverage. Some may think that due to the fact that the wave transmitted is horizontally polarized it is quite necessary that a horizontal antenna be employed on the aircraft for best reception. As stated before, either vertical or horizontal polarization may be used, and the best antenna for aircraft is the 1/2 wave vertical. Conducted tests indicate that the antenna just mentioned works very well for aircraft contacts.

Exact antenna design for the frequencies mentioned for airport operations is governed by the type of equipment supplied by the manufacturer who usually recommends the antenna which operates most efficiently with his equipment. In case the technician is called upon to install the transmitter, receiver, and antenna components at an airport station, he should consult the equipment manufacturer and those engineers who have had experience in installing such equipment. Much time will be saved, if this is done.

BUY DIRECT FROM THE MANUFACTURER AND SAVE

WE KNOW OUR PRICES ARE VERY LOW and expect a certain amount of skepticism from servicemen who have never purchased the SUPERIOR way, but seven years of sticking to our way of doing business has convinced us and many thousands of servicemen who have purchased from us that it is a practical and mutually profitable way of doing business. We know that the average income of the Radio Serviceman prohibits his purchasing high-priced equipment, and yet the very nature of his work makes it necessary for him to use accurate, dependable and up-to-date equipment. We know we have solved the problem for him and our continually expanding business proves that servicemen recognize this claim to be true.

BESIDES THE THOUSANDS OF SERVICEMEN AND TECHNICIANS, THE FOLLOWING WELL-KNOWN NAMES ARE LISTED AMONG SUPERIOR INSTRUMENT PURCHASERS: Standard Oil Company of New Jersey; U. S. Dept. of Agriculture; U. S. Dept. of Commerce; U. S. War Department; C.C.C. Camps; National Youth Administration; Goodyear Tire and Rubber Co.; E. I. duPont de Nemours & Co.; University of Nebraska; Leland Stanford Junior University; Westminster College; Oberlin College; University of Michigan; Boston College; Pomona College; Board of Education, Remus, Michigan; Board of Education, City of New York; Board of Vocational Education, State of Illinois; City of Bartow, Florida; Florida State Dept. of Education; Educational Dept., Custer, North Dakota.



The New Model 1220 POCKET LABORATORY

★ WEIGHS ONLY 28 OUNCES!!
★ USES a 2% ACCURATE 0-200 MICROAMMETER—ENABLING MEASUREMENTS AT

5000 OHMS PER VOLT

SPECIFICATIONS

- ★ 6 D.C. Voltage Ranges: 0-3-10-50-250-500-5,000 volts.
- ★ 3 A.C. Voltage Ranges: 0-15-150-1,500 volts.
- ★ 4 Resistance Ranges: 0-3000 ohms, with 15 ohm center, direct reading to 0.2 ohm; foregoing base range multiplied by 10, by 100 and by 1,000, to read up to 3 Meg. with self-contained 3 V. flashlight battery.
- ★ D.C. Current Ranges: 0-200 microamperes; 0-2-20-200 Milliampers, using wire-wound shunts.
- ★ 3 Output Meter Ranges: Same as A.C. Voltage Ranges.
- ★ 3 Decibel Ranges: From -2 to +58 D.B., based on .006 watt in 500 ohms.

Model 1220 comes complete with cover, self-contained battery, test leads and instructions. ONLY.....

\$10⁴⁵

THE NEW CHANNEL-ANALYZER

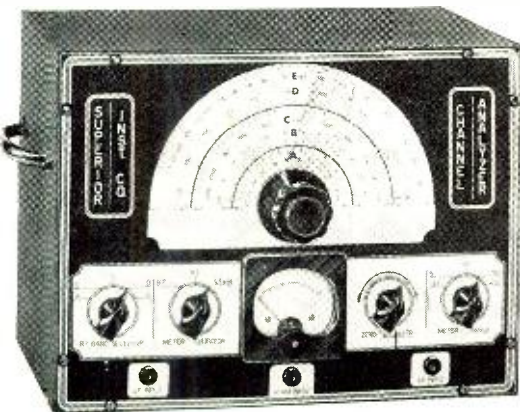

FOLLOWS THE SIGNAL

FROM ANTENNA TO SPEAKER OF ANY SET

The well-established and authentic SIGNAL TRACING METHOD of locating the very circuit in which there is trouble, and the very component that causes the trouble, is now for the first time available at a price any radio serviceman can afford.

THE CHANNEL-ANALYZER WILL

- ★ Follow the signal from antenna to speaker through all stages of any receiver ever made.
- ★ Instantly track down exact cause of intermittent operation.
- ★ Measure both Automatic-Volume-Control and Automatic-Frequency-Control, voltages and circuits without appreciably loading the circuit, using built-in highly sensitive Vacuum-Tube Voltmeter.
- ★ Check exact gain of every individual stage in receiver.
- ★ Track down and locate cause of distortion in R.F., I.F., and A.F. amplifier.
- ★ Check exact operating voltage of each tube.
- ★ Locate leaky condensers and all high-resistance shorts, also show opens.
- ★ Measure exact frequencies, amount of drift and comparative output of oscillators in superhets.
- ★ Track down exact cause of noise.

The Superior Channel-Analyzer comes housed in shielded cabinet and features an attractive etched aluminum panel. Supplied complete with tubes, three specially engineered shielded input cables, each identified as to its purpose. Also full operating instructions. Size 13" x 10" x 6". Shipping weight 19 pounds. Only....

\$19⁷⁵

Canadian Distributors; Radio Parts Supply

The New Model 1240 TUBE TESTER

Instantaneous snap switches reduce actual testing time to absolute minimum. Tests all tubes 1.4 to 117 volts.

Sockets for all tubes—No adapters.

SPECIFICATIONS:

- ★ Tests all tubes, 1.4 to 117 volts, including 4, 5, 6, 7, 7L, octals, locals, Bantam, Jr., Peanut, single ended, floating filament, Mercury Vapor Rectifiers, the new S series, in fact, every tube designed to date.
 - ★ Spare socket included on front panel for any future tubes.
 - ★ Tests by the well-established emission method for tube quality, directly read on the GOOD ? BAD scale of the meter.
 - ★ Jewel protected neon.
 - ★ Tests shorts and leakages up to 2 megohms in all tubes.
 - ★ Tests leakages and shorts in all elements AGAINST all elements in all tubes.
 - ★ Tests BOTH plates in rectifiers.
 - ★ Tests individual sections such as diodes, triodes, pentodes, etc., in multi-purpose tubes.
 - ★ Latest type voltage regulator.
 - ★ Features an attractive etched aluminum panel.
 - ★ Works on 90 to 125 volts 60 cycles A.C.
- Model 1240 comes complete with instructions and tabular data for every known type of receiving tube. Shipping weight 12 pounds. Size 6" x 7 1/2" x 10 3/4".
- Our Net Price.....



PORTABLE COVER \$1.00 ADDITIONAL

\$11⁸⁵

MODEL 1230 SIGNAL GENERATOR



WITH FIVE STEPS OF SINE-WAVE AUDIO

SPECIFICATIONS:

1. Combination R.F. and A.F. Signal Generator. R.F.—100 K.C. to 90 Mcgacycles. A.F.—200 to 7500 cycles; Sine-Wave.—WITH OUTPUT OF OVER 1 VOLT. All direct reading, all by front panel switch manipulation.
2. R.F. and A.F. output independently obtainable, alone or with A.F. (any frequency) modulating R.F.
3. Latest design full-range attenuator used for controlling either the pure or modulated R.F.
4. Accuracy is within 1% on I.F. and broadcast bands; 2% on higher frequencies.
5. Giant dial etched directly on front panel, using a new mechanically perfected drive for perfect vernier control.
6. Operates on 90 to 130 V. A.C. or D.C. (any frequency).

The Model 1230 comes complete with tubes, shielded cables, molded carrying handle and instructions. Size 14" x 6" x 11". Shipping weight 15 pounds. Only....

\$12⁸⁵

Company, 962 Bleury St., Montreal, Canada

SUPERIOR INSTRUMENTS CO.

136 Liberty St., Dept. RN9
New York, N. Y.

You Need THIS In Your Business NOW!

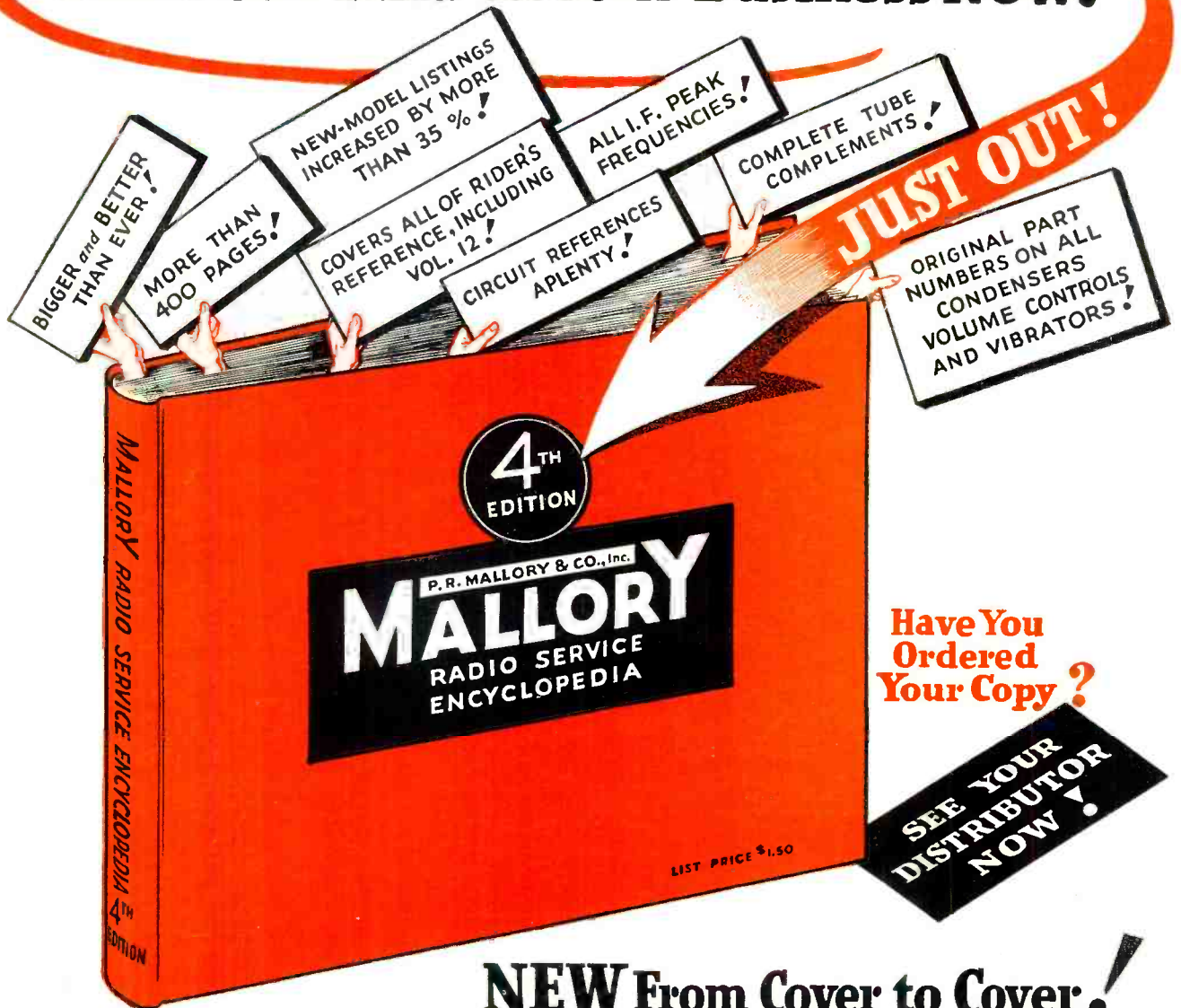

Have You Ordered Your Copy?

SEE YOUR DISTRIBUTOR NOW!

NEW From Cover to Cover!

Here's a Volume Control That's *Something!*



... a real contribution to the speed and quality of your service work. New mechanical and electrical precision. Rugged! An A-C switch that snaps on and stays on. Quiet! Start using them *today!*

Mallory Replacement Condensers are Tops!



More service engineers are using more Mallory Replacement Condensers than ever! Save time and protect your reputation with Mallory Replacement Condensers!

Save your old Aluminum parts. It is patriotic to give them to National Defense.

You better order your copy of this new, 4th edition MYE *right this minute!* Because our Mallory distributors tell us that they're practically sold out. And, Mister, you're going to kick yourself, if you don't get a copy. You need this MYE in your business—and you need it NOW!

So *now* is the time to order. Pick up the phone and call your Mallory distributor . . . tell him you've GOT to have a copy of the new, 4th edition MYE!

P. R. MALLORY & CO., Inc., INDIANAPOLIS, INDIANA

More than ever —INSIST ON

P.R. MALLORY & CO. Inc.
MALLORY
APPROVED
PRECISION PRODUCTS

VIBRATORS • VIBRAPACKS • CONDENSERS •
VOLUME CONTROLS • ROTARY SWITCHES •
SINGLE AND MULTIPLE PUSH BUTTON SWITCHES
• RESISTORS • RADIO HARDWARE